

MC67 USER GUIDE



MC67 USER GUIDE

72E-161697-04

Rev. A

March 2015

No part of this publication may be reproduced or used in any form, or by any electrical or mechanical means, without permission in writing from Zebra. This includes electronic or mechanical means, such as photocopying, recording, or information storage and retrieval systems. The material in this manual is subject to change without notice.

The software is provided strictly on an “as is” basis. All software, including firmware, furnished to the user is on a licensed basis. Zebra grants to the user a non-transferable and non-exclusive license to use each software or firmware program delivered hereunder (licensed program). Except as noted below, such license may not be assigned, sublicensed, or otherwise transferred by the user without prior written consent of Zebra. No right to copy a licensed program in whole or in part is granted, except as permitted under copyright law. The user shall not modify, merge, or incorporate any form or portion of a licensed program with other program material, create a derivative work from a licensed program, or use a licensed program in a network without written permission from Zebra. The user agrees to maintain Zebra’s copyright notice on the licensed programs delivered hereunder, and to include the same on any authorized copies it makes, in whole or in part. The user agrees not to decompile, disassemble, decode, or reverse engineer any licensed program delivered to the user or any portion thereof.

Zebra reserves the right to make changes to any software or product to improve reliability, function, or design.

Zebra does not assume any product liability arising out of, or in connection with, the application or use of any product, circuit, or application described herein.

No license is granted, either expressly or by implication, estoppel, or otherwise under any Zebra Technologies Corporation, intellectual property rights. An implied license only exists for equipment, circuits, and subsystems contained in Zebra products.

Revision History

Changes to the original guide are listed below:

Change	Date	Description
-01 Rev. A	09/19/12	Initial release.
-02 Rev. A	08/30/13	Add CDMA WAN support.
-03 Rev. A	06/30/14	Add support for Ortus display. Changes due to OEM version 03.46.36 (ALC, keylight registry settings, red LED during scanning disabled).
-04 Rev. A	3/11/15	Zebra Rebranding

TABLE OF CONTENTS

Revision History	iii
------------------------	-----

About This Guide

Introduction	xiii
Documentation Set	xiii
Configurations	xiii
Software Versions	xiv
Chapter Descriptions	xiv
Notational Conventions	xv
Related Documents	xv
Service Information	xvi

Chapter 1: Getting Started

Introduction	1-1
Unpacking	1-1
Getting Started	1-2
Installing a microSD Card	1-2
Installing the SIM Card	1-3
Installing the Battery	1-4
Charging the Battery	1-5
Charging the Main Battery	1-5
Charging Spare Batteries	1-6
Charging Temperature	1-6
Powering On the MC67	1-6
Calibrating the Screen	1-6
Checking Battery Status	1-6
Replacing the Battery	1-7
Replacing the microSD Card	1-7
Replacing the SIM Card	1-8
Battery Management	1-9
Changing the Power Settings	1-9
Changing the Backlight Settings	1-9
Changing the Keypad Backlight Settings	1-9

Turning Off the Radios	1-10
------------------------------	------

Chapter 2: Using the MC67

Introduction	2-1
Features	2-1
LED Indicators	2-2
Keypads	2-3
Finger Scrolling	2-4
Home Screen	2-4
Classic Today Screen	2-6
Status Bar	2-7
Tile Bar	2-10
Adjusting Volume	2-12
Resetting the MC67	2-12
Performing a Warm Boot	2-12
Performing a Cold Boot	2-12
Locking the MC67	2-12
Un-locking with Simple PIN	2-13
Un-locking with Strong Password	2-13
Battery Status Indications	2-14
Battery Reserve Options	2-15
Main Battery Temperature Notifications	2-16
Interactive Sensor Technology	2-17
Power Management	2-17
Display Orientation	2-17
Free Fall Detection	2-17
Stylus	2-18
Entering Data	2-18
Using Voice-Over-IP	2-19

Chapter 3: Data Capture

Introduction	3-1
Imaging	3-1
Operational Modes	3-1
Digital Camera	3-2
Scanning Considerations	3-2
Imager Scanning	3-3
Digital Camera Scanning	3-4
Using the RS507 Hands-free Imager	3-4
DataWedge	3-5
Enable DataWedge	3-5
Disable DataWedge	3-5
Taking Pictures	3-6
Burst Mode	3-6
Timer Mode	3-6
Editing Pictures	3-7
Setting a Picture as Wallpaper	3-7
Camera Configuration	3-7
Recording a Video	3-8

Video Configuration	3-8
Viewing Pictures and Videos	3-9
Customizing Pictures & Videos	3-9

Chapter 4: Making Calls

Introduction	4-1
Making a Call	4-1
Using the Phone Keypad	4-1
Smart Dialing	4-2
Using Contacts	4-3
Using Call History	4-3
Making a Speed Dial Call	4-4
Answering a Call	4-4
Incoming Call Features	4-5
Missed Call Notification	4-5
Emergency Calling	4-5
Audio Modes	4-5
Using a Bluetooth Headset	4-6
Adjusting Audio Volume	4-6
Muting a Call	4-6
Taking Notes	4-6
Using Call History	4-7
Managing Call History	4-7
Changing the Call History View	4-7
Resetting the Recent Calls Counter	4-8
Deleting All Call History Items	4-8
Viewing Call Status	4-8
Using the Call History Menu	4-9
Conference Calling	4-10
Swapping Calls	4-10
Speed Dial Setup	4-11
Adding a Speed Dial Entry	4-11
Editing a Speed Dial Entry	4-13
Deleting a Speed Dial Entry	4-14

Chapter 5: Using WLAN

Introduction	5-1
Fusion Overview	5-1
Connecting to the Internet	5-2
Supported Applications	5-2
Fusion Setup	5-3

Chapter 6: Messaging

Introduction	6-1
Email	6-1
Creating an Email Message	6-1
Viewing an Email Message	6-1
Replying to a Message	6-2

Text Messaging	6-2
Viewing Text Messages	6-2
Sending a Text Message	6-4
Using a Dual Line SIM	6-5

Chapter 7: Bluetooth

Introduction	7-1
Adaptive Frequency Hopping	7-1
Security	7-2
Security Mode 3 (Link Level Encryption)	7-2
Microsoft Bluetooth Stack	7-2
StoneStreet One Bluetooth Stack	7-2
FIPS 140-2	7-3
Bluetooth Configuration	7-4
Bluetooth Power States	7-5
Cold Boot	7-5
Warm Boot	7-5
Suspend	7-5
Resume	7-6
Using Microsoft Bluetooth Stack	7-6
Turning the Bluetooth Radio Mode On and Off	7-6
Enabling Bluetooth	7-6
Disabling Bluetooth	7-6
Discovering Bluetooth Device(s)	7-7
Available Services	7-9
Object Push Services via Beam	7-9
Internet Sharing	7-10
Serial Port Services	7-11
ActiveSync Using Serial Port Services	7-12
Phone Book Access Profile Services	7-13
Using Bluetooth StoneStreet One Bluetooth Stack	7-14
Turning the Bluetooth Radio Mode On and Off	7-14
Disabling Bluetooth	7-14
Enabling Bluetooth	7-14
Modes	7-14
Wizard Mode	7-14
Explorer Mode	7-14
Discovering Bluetooth Device(s)	7-15
Available Services	7-18
File Transfer Services	7-18
Connecting to the Internet Using an Access Point	7-20
Dial-Up Networking Services	7-20
Add a Dial-up Entry	7-22
Object Exchange Push Services	7-23
Headset Services	7-26
Serial Port Services	7-27
ActiveSync Using Serial Port Services	7-27
Personal Area Network Services	7-29
A2DP/AVRCP Services	7-29
Connect to a HID Device	7-30

Pairing with Discovered Device(s)	7-30
Bluetooth Settings	7-32
Device Info	7-32
Services	7-32
Security	7-37
Discovery	7-37
Virtual COM Port	7-38
HID	7-38
Profiles	7-39
System Parameters	7-39
Miscellaneous	7-39

Chapter 8: Using GPS Navigation

Introduction	8-1
Software Installation	8-1
MC67 GPS Setup	8-1
Operation	8-2
GPS Maps on microSD Cards	8-2
Answering a Phone Call While Using GPS	8-2
Losing the GPS Signal While in a Vehicle	8-2
Assisted GPS	8-2

Chapter 9: Settings

Settings Folder	9-1
Locking the MC67	9-4
Power Settings	9-4
Backlight Settings	9-5
Keypad Backlight Settings	9-5
USB Configuration	9-5
UI Settings	9-6
Start Screen Settings	9-6
IE Zoom Mapping	9-6
IST Settings	9-8
Info Tab	9-8
Display Tab	9-8
Power Management Tab	9-8
On Face Down	9-9
Keep Alive On Motion	9-9
Setting Sensitivity	9-9
Events Tab	9-10
Sensors Tab	9-10
Email Setup	9-12
Setting Up an IMAP or POP Account	9-12
Automatic Email Setup	9-12
Manual Email Setup	9-13
Entering Email Settings Manually	9-13
Editing an Email Account	9-14
Setting Email Signatures	9-15

Chapter 10: Accessories

Introduction	10-1
Accessories	10-1
Single Slot USB Cradle	10-3
Charging the MC67 Battery	10-3
Charging the Spare Battery	10-4
Battery Charging Indicators	10-4
Charging Temperature	10-4
Single-slot Ethernet/Modem/USB Cradle	10-5
Country Settings	10-5
Connection Setup	10-5
Indicators	10-6
Operation	10-6
Ethernet Connection	10-6
Modem Connection	10-6
Four Slot Charge Only Cradle	10-7
Charging	10-7
Battery Charging Indicators	10-7
Charging Temperature	10-7
Four Slot Ethernet Cradle	10-8
Charging	10-8
Communication	10-8
LED Indicators (CRD5500-4000ER)	10-9
LED Indicators (CRD5501-4000ER)	10-9
VCD5000 Vehicle Cradle	10-10
Charging the MC67 Battery	10-10
Removing the MC67	10-10
Battery Charging Indicators	10-11
Charging Temperature	10-11
Four Slot Battery Charger	10-12
Battery Charging	10-12
Battery Charging Indicators	10-12
Charging Temperature	10-12
Cables	10-13
Battery Charging and Operating Power	10-13
LED Charge Indications	10-14
Charging Temperature	10-14
Trigger Handle	10-15
Inserting the MC67 into the Trigger Handle	10-15
Removing the MC67	10-15
Scanning	10-15

Chapter 11: Maintenance & Troubleshooting

Introduction	11-1
Maintaining the MC67	11-1
Removing the Screen Protector	11-2
Battery Safety Guidelines	11-2
Cleaning	11-3
Materials Required	11-3
Cleaning the MC67	11-4

Housing	11-4
Display	11-4
Scanner Exit Window	11-4
Connector	11-4
Cleaning Cradle Connectors	11-4
Cleaning Frequency	11-5
Troubleshooting	11-5
MC67	11-5
Single Slot USB Cradle	11-8
Four Slot Ethernet Cradle	11-9
Vehicle Cradle	11-9
Four Slot Battery Charger	11-10
Cables	11-10
Magnetic Stripe Reader	11-11

Appendix A: Technical Specifications

MC67	A-1
------------	-----

Appendix B: Keypads

Introduction	B-1
Numeric Keypad Configuration	B-1
Alpha-numeric Keypad Configurations	B-5
PIM Keypad Configuration	B-13
DSD Keypad Configuration	B-15
Special Character Key	B-18

Glossary

Index

ABOUT THIS GUIDE

Introduction

This guide provides information about using the MC67 mobile computer and accessories.

✓ **NOTE** Screens and windows pictured in this guide are samples and can differ from actual screens.

Documentation Set

The documentation set for the MC67 provides information for specific user needs, and includes:

- *MC67 Quick Start Guide* - describes how to get the MC67 up and running.
- *MC67 User Guide* - describes how to use the MC67.
- *MC67 Integrator Guide* - describes how to set up the MC67 and accessories.
- *Enterprise Mobility Developer Kit (EMDK) Help File* - provides API information for writing applications.

Configurations

This guide covers the following configurations:

Configuration	Radios	Display	Memory	Data Capture Options	Operating System	Keypads
MC67NA	WLAN: 802.11 a/b/g/n WPAN: Bluetooth v2.1 EDR WWAN: GSM/UMTS GPS: Stand-alone GPS or A-GPS	3.5" VGA Color	512 MB RAM/ 2 GB Flash	2D imager or 2D imager and camera	Windows Embedded Handheld 6.5	Numeric, QWERTY, QWERTZ, AZERTY, PIM or DSD
MC67ND	WLAN: 802.11 a/b/g/n WPAN: Bluetooth v2.1 EDR WWAN: GSM/UMTS or 1XRTT/CDMA GPS: Stand-alone GPS or A-GPS	3.5" VGA Color	1 GB RAM/ 8 GB Flash	2D imager or 2D imager and camera	Windows Embedded Handheld 6.5	Numeric, QWERTY, QWERTZ, AZERTY or DSD

Software Versions

This guide covers various software configurations and references are made to operating system or software versions for:

- Adaptation Kit Update (AKU) version
- OEM version
- Fusion software
- Phone software.

AKU Version

To determine the Adaptation Kit Update (AKU) version:

Tap  > **Settings** > **System** > **About** > **Version**.

The second line lists the operating system version and the build number. The last part of the build number represents the AKU number. For example, *Build 29058.5.3.12.8* indicates that the device is running AKU version 5.3.12.8.

OEM Version

To determine the OEM software version:

Tap  > **Settings** > **System** > **System Info** > **System**.



Fusion Software

To determine the Fusion software version:

Tap  > **Wireless Companion** > **Wireless Status** > **Versions**.

Phone Software

To determine the Phone software version:

Press  >  > **Phone information**.

Chapter Descriptions

Topics covered in this guide are as follows:

- [Chapter 1, Getting Started](#) provides information on getting the MC67 up and running for the first time.
- [Chapter 2, Using the MC67](#) provides basic instructions for using the MC67, including powering on and resetting the MC67.
- [Chapter 3, Data Capture](#) provides instructions for capturing data.
- [Chapter 4, Making Calls](#) provides setup instructions for the MC67 phone.
- [Chapter 5, Using WLAN](#) provides information for connection the MC67 to a WLAN.
- [Chapter 6, Messaging](#) provides information for using Email, SMS and MMS messaging.
- [Chapter 7, Bluetooth](#) explains Bluetooth functionality on the MC67.
- [Chapter 8, Using GPS Navigation](#) provides information about GPS navigation with the MC67.
- [Chapter 9, Settings](#) provides basic instructions for using the MC67 phone.
- [Chapter 10, Accessories](#) describes the available accessories and how to use them with the MC67.
- [Chapter 11, Maintenance & Troubleshooting](#) includes instructions on cleaning and storing the MC67, and provides troubleshooting solutions for potential problems during MC67 operation.
- [Appendix A, Technical Specifications](#) provides the technical specifications for the MC67.
- [Appendix B, Keypads](#) Provides information on the various keypad configuration.

Notational Conventions

The following conventions are used in this document:

- Mobile computer refers to the MC67 series of hand-held computers.
- *Italics* are used to highlight the following:
 - Chapters and sections in this and related documents
 - Icons on a screen.
- **Bold** text is used to highlight the following:
 - Dialog box, window, and screen names
 - Drop-down list and list box names
 - Check box and radio button names
 - Key names on a keypad
 - Button names on a screen.

- Bullets (•) indicate:
 - Action items
 - Lists of alternatives
 - Lists of required steps that are not necessarily sequential
- Sequential lists (e.g., those that describe step-by-step procedures) appear as numbered lists.

Related Documents

- *MC67 Quick Start Guide*, p/n 72-116172-xx.
- *MC67 Regulatory Guide*, p/n 72-116171-xx.
- *MC67 Integrator Guide*, p/n 72E-161698-xx.
- *Mobility Services Platform User Guide*, p/n 72E-100158-xx.
- *Enterprise Mobility Developer Kits (EMDKs)*, available at: <http://www.zebra.com/support>.
- Latest ActiveSync or Windows Mobile Device Center software, available at: <http://www.microsoft.com>.

For the latest version of this guide and all guides, go to: <http://www.zebra.com/support>.

Service Information

If the user has a problem with the equipment, contact Zebra Global Customer Support in the region. Contact information is available at: <http://www.zebra.com/support>.

When contacting support, please have the following information available:

- Serial number of the unit (found on manufacturing label)
- Model number or product name (found on manufacturing label)
- Software type and version number
- IMEI number.

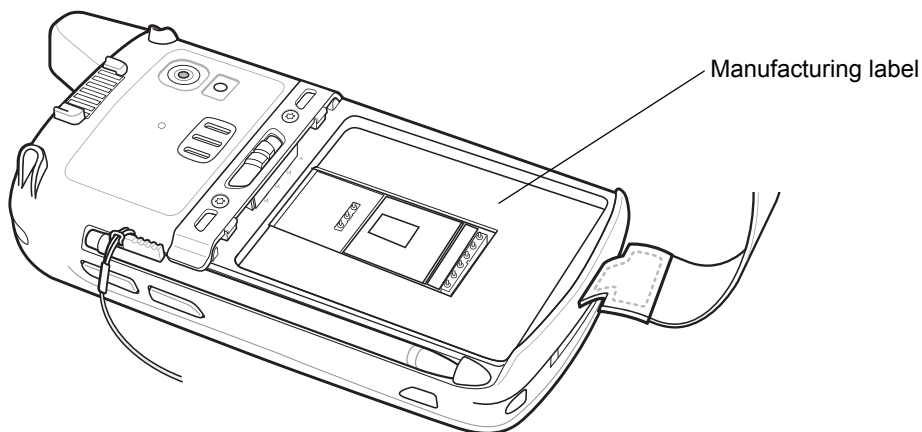

Zebra responds to calls by email, telephone or fax within the time limits set forth in support agreements.

If the problem cannot be solved by Zebra Global Customer Support, the user may need to return the equipment for servicing and will be given specific directions. Zebra is not responsible for any damages incurred during shipment if the approved shipping container is not used. Shipping the units improperly can possibly void the warranty. Remove the SIM card and/or microSD card from the MC67 before shipping for service.

If the device was purchased from a Zebra business partner, contact that business partner for support.

CHAPTER 1 GETTING STARTED

Introduction

This chapter lists the parts and accessories for the MC67 and explains how to set up the MC67 for the first time.

Unpacking

Carefully remove all protective material from the MC67 and save the shipping container for later storage and shipping.

Verify that the following were received:

- MC67 mobile computer
- 3600 mAh Lithium-ion battery
- stylus with tether (installed)
- Regulatory Guide
- Quick Start Guide.

Inspect the equipment for damage. If any equipment is missing or damaged, contact the Zebra Global Customer Support center immediately. See [page xvi](#) for contact information.

Prior to using the MC67 for the first time, remove the protective shipping film that covers the scan window, display and camera window.

Getting Started

To start using the MC67 for the first time:

1. Install a micro secure digital (SD) card (optional)
2. Install the subscriber identification module (SIM) card (GSM/UMTS only)
3. Install the battery.
4. Charge the MC67.
5. Power on the MC67.

Installing a microSD Card

The microSD card slot provides secondary non-volatile storage. The slot is located under the battery pack. Refer to the documentation provided with the card for more information, and follow the manufacturer's recommendations for use.



CAUTION Follow proper electrostatic discharge (ESD) precautions to avoid damaging the microSD card. Proper ESD precautions include, but are not limited to, working on an ESD mat and ensuring that the operator is properly grounded.

To install the microSD card:

1. Remove the handstrap.
2. Lift the rubber access door.
3. Slide the SIM card holder door up to unlock.
4. Lift the SIM card holder door.

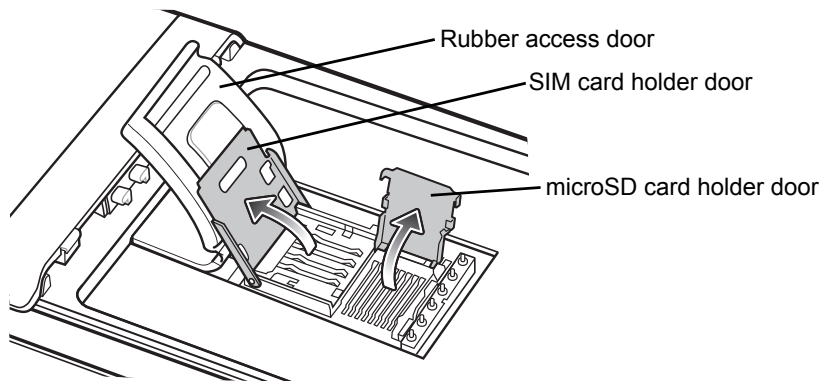

Figure 1-1 Lift SIM Slot Holder Door

5. Lift the microSD card holder door.
6. Insert the microSD card into the card holder door ensuring that the card slides into the holding tabs on each side of the door.

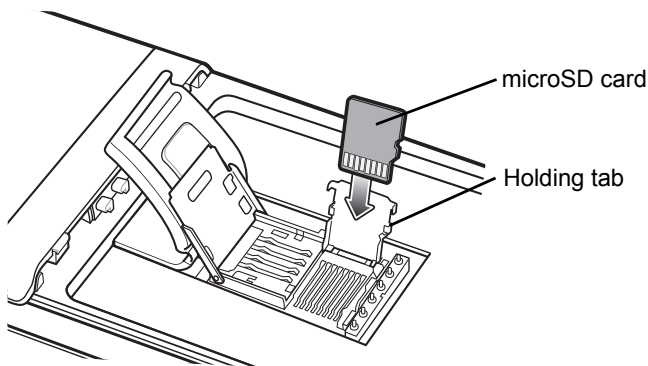

Figure 1-2 Insert microSD Card in Holder

7. Close the card holder door and push down until it is securely in place.
8. If installing a SIM card, proceed to [Installing the SIM Card](#).
9. Close the SIM card holder door and slide down until it locks into place.
10. Close the rubber access door.

Installing the SIM Card

✓ **NOTE** GSM/UMTS networks only.

Global System for Mobile communications (GSM) phone service requires a SIM card. Obtain the card from a service provider. The card fits into the MC67 and can contain the following information:

- Mobile phone service provider account details.
- Information regarding service access and preferences.
- Contact information, which can be moved to Contacts on the MC67.
- Any additional subscribed services.

✓ **NOTE** For more information about SIM cards, refer to the service provider's documentation.

To install the SIM card:

1. Lift rubber access door.
2. Slide the SIM card holder up to unlock.
3. Lift the SIM card holder door.

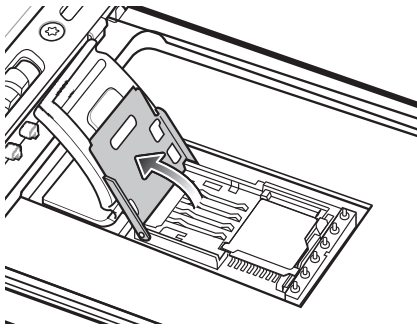

Figure 1-3 *Lifting the SIM Cover*

4. Insert the SIM card, as shown in [Figure 1-4](#) ensuring that the card slides into the holding tabs on each side of the door.

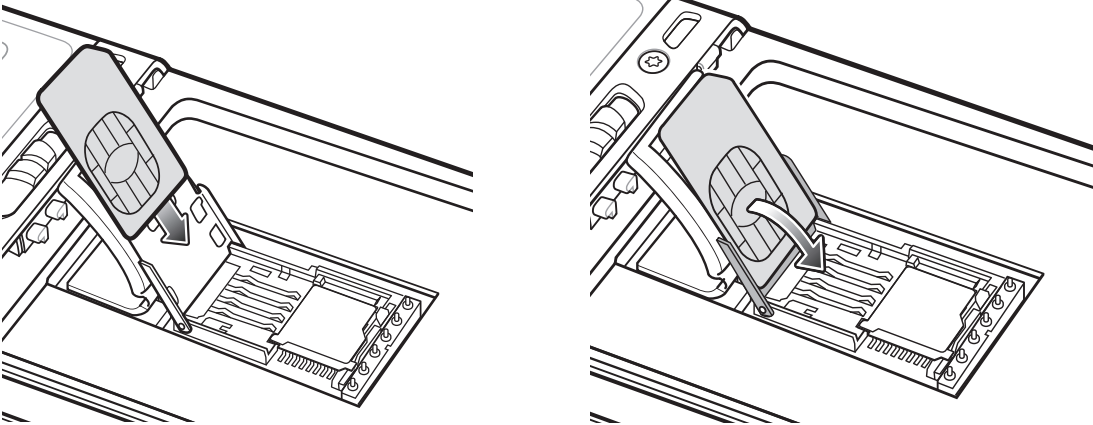

Figure 1-4 *Inserting the SIM Card*

5. Close the SIM card holder door and slide down to lock into place.
6. Close the rubber access door.
7. Install the battery.

Installing the Battery

To install the battery.

1. Insert the battery, bottom first, into the battery compartment in the back of the MC67.
2. Press the battery down into the battery compartment until the battery release latch snaps (two clicks) into place.

✓ **NOTE** If the battery has significant charge, the MC67 turns on.

3. Replace the handstrap.

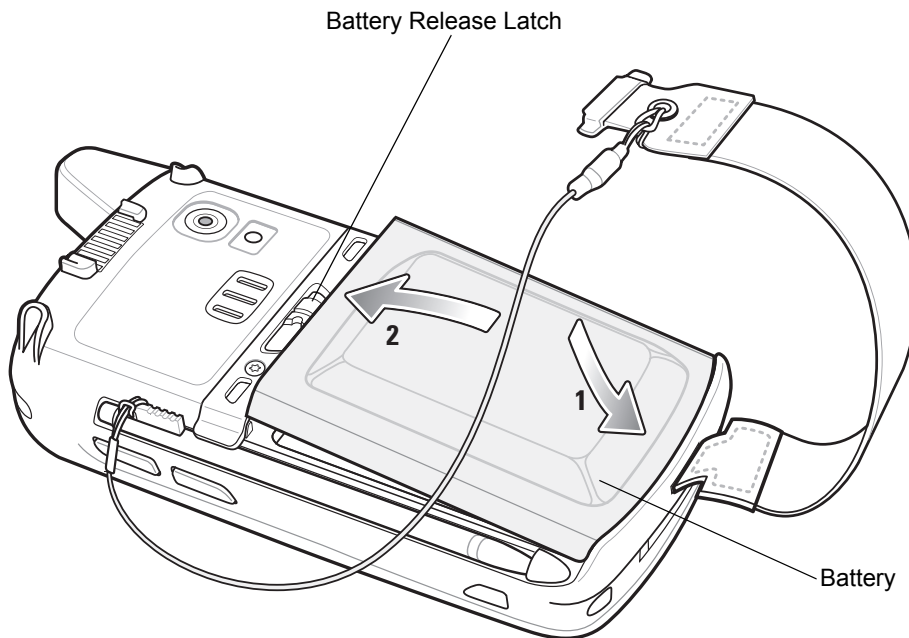

Figure 1-5 Inserting the Battery

Charging the Battery



CAUTION Ensure to follow the guidelines for battery safety described in [Battery Safety Guidelines on page 11-2](#).

Charging the Main Battery

Before using the MC67 for the first time, charge the main battery until the amber Charging/Battery Status light emitting diode (LED) remains lit (see [Table 1-1 on page 1-6](#) for charge status indications). To charge the MC67, use a cable or a cradle with the appropriate power supply. For information about the accessories available for the MC67, see [Chapter 10, Accessories](#).

The MC67 is equipped with a backup battery which automatically charges from the fully-charged main battery. When using the MC67 for the first time, the backup battery requires approximately 40 hours to fully charge. This is also true any time the backup battery is discharged, which occurs when the main battery is removed for several hours. The backup battery retains random access memory (RAM) data in memory for at least 15 minutes (at room temperature) when the MC67's main battery is removed. When the MC67 reaches a very low battery state, the combination of main battery and backup battery retains RAM data in memory for at least 36 hours.

For cable and cradle setup and charging procedures refer to the *MC67 Integrator Guide*.

- USB Charging Cable
- Charge Only Cable
- Single Slot USB Cradle
- Four Slot Charge Only Cradle
- Four Slot Ethernet Cradle.

To charge the main battery:

1. Connect the charging accessory to the appropriate power source.
2. Insert the MC67 into a cradle or attach to a cable. The MC67 begins charging. The Charging/Battery Status LED blinks amber while charging, then turns solid amber when fully charged. See [Table 1-1](#) for charging indications.

The 3600 mAh battery charges in less than six hours.

Table 1-1 LED Charge Indicators

Charging/Battery Status LED	Indication
Off	MC67 is not charging. MC67 is not inserted correctly in the cradle or connected to a power source. Charger/cradle is not powered.
Slow Blinking Amber (1 blink every 2 seconds)	MC67 is charging.
Solid Amber	Charging complete. Note: When the battery is initially inserted in the MC67, the amber LED flashes once if the battery power is low or the battery is not fully inserted.
Fast Blinking Amber (2 blinks/second)	Charging error, e.g.: <ul style="list-style-type: none"> • Temperature is too low or too high. • Charging has gone on too long without completion (typically eight hours).

Charging Spare Batteries

See [Chapter 10, Accessories](#) for information on using accessories to change spare batteries.

Charging Temperature

Charge batteries in temperatures from 0 °C to 40 °C (32 °F to 104 °F). Note that charging is intelligently controlled by the MC67.

To accomplish this, for small periods of time, the MC67 or accessory alternately enables and disables battery charging to keep the battery at acceptable temperatures. The MC67 or accessory indicates when charging is disabled due to abnormal temperatures via its LED. See [Table 1-1](#).

Powering On the MC67

✓ **NOTE** If during installation of the battery, the battery has significant charge the MC67 turns on.

Press the Power button to turn on the MC67. The splash screen displays for about a minute as the MC67 initializes its flash file system, then the calibration window appears.

Calibrating the Screen

- ✓ **NOTE** The Calibration screen can be accessed by pressing **Blue** key then **Backspace** key. On the Personal Information Manager (PIM) keypad, tap  **Settings** > **System** > **Screen** > **Align Screen**.

To calibrate the screen so the cursor on the touch screen aligns with the tip of the stylus:

1. Remove the stylus from its holder on the side of the MC67.
2. Carefully press and briefly hold the tip of stylus on the center of each target that appears on the screen.
3. Repeat as the target moves around the screen, then tap the screen to continue.

Checking Battery Status

To check the charge status of the main battery in the MC67, tap  > **Settings** > **Power** to display the **Power** window.

Replacing the Battery



CAUTION The MC67 backup battery retains data for up to 15 minutes. Replace the battery within 15 minutes to ensure that application states are maintained and that data is not lost.

1. If the MC67 is in a cradle, remove it before performing a Safe Battery Swap.
2. If the MC67 is in suspend mode, press the red **Power** button to wake the device.
3. Press the red **Power** button. The **Power Action Key** window appears.
4. Tap **Safe Battery Swap**. The Data Capture LED lights red.
5. When the LED turns off, remove the handstrap.
6. Slide the battery latch to the right. The battery ejects slightly.

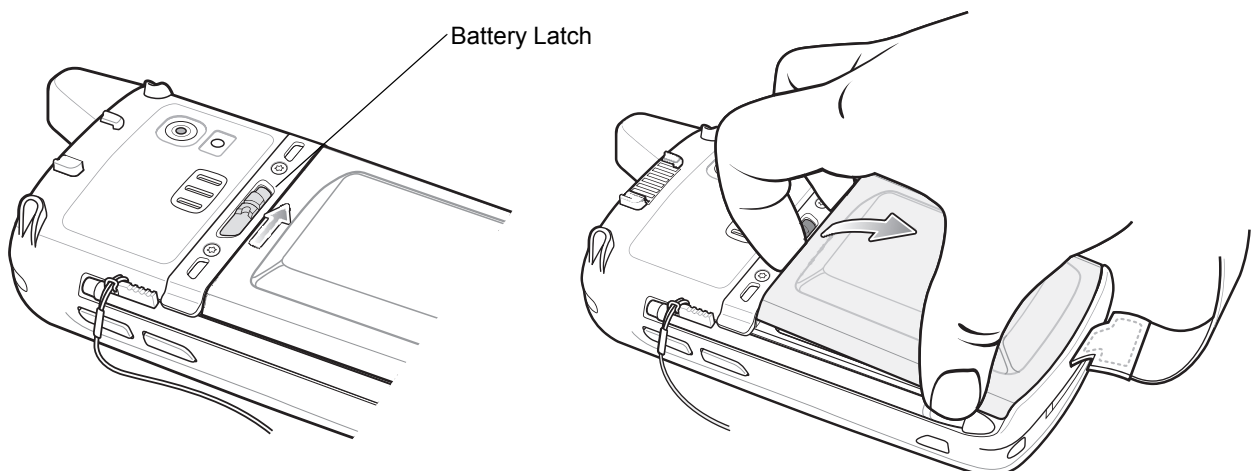

Figure 1-6 Removing the Battery

7. Lift the battery from the MC67.
8. Insert the replacement battery, bottom first, into the battery compartment in the back of the MC67.
9. Press the battery down until the battery release latch snaps (two clicks) into place.
10. Replace the handstrap.

Replacing the microSD Card



CAUTION The MC67 backup battery retains data for up to 15 minutes. Replace the battery within 15 minutes to ensure that application states are maintained and that data is not lost.

To replace an microSD card:

1. If the MC67 is in a cradle, remove it before performing a Safe Battery Swap.
2. If the MC67 is in suspend mode, press the red **Power** button to wake the device.
3. Press the red **Power** button. The **Power Action Key** window appears.
4. Tap **Safe Battery Swap**. The Data Capture LED lights red.
5. When the LED turns off, remove the handstrap.
6. Remove the battery.
7. Lift the rubber access door.
8. Slide SIM card holder door up to unlock.
9. Lift SIM Card holder door.
10. Lift the microSD card holder door.
11. Remove microSD card from holder.
12. Close microSD card holder door.
13. Close SIM card holder door.
14. Slide SIM card holder door down to lock into place.
15. Close the rubber access door.
16. Insert the battery, bottom first, into the battery compartment in the back of the MC67.
17. Press the battery down until the battery release latch snaps (two clicks) into place.
18. Replace the handstrap.
19. If a SIM card is installed, warm boot the MC67. See [Resetting the MC67 on page 2-12](#).

Replacing the SIM Card



CAUTION The MC67 backup battery retains data for up to 15 minutes. Replace the battery within 15 minutes to ensure that application states are maintained and that data is not lost.

To replace a SIM card:

1. If the MC67 is in a cradle, remove it before performing a Safe Battery Swap.
2. If the MC67 is in suspend mode, press the red **Power** button to wake the device.
3. Press the red **Power** button. The **Power Action Key** window appears.
4. Tap **Safe Battery Swap**. The Data Capture LED lights red.
5. When the LED turns off, remove the handstrap.
6. Remove the battery.
7. Lift the rubber access door.
8. Slide SIM card holder door up to unlock.
9. Lift the SIM Card holder door.
10. Remove SIM card from holder.
11. Close SIM card holder door.
12. Slide SIM card holder door down to lock into place.
13. Close the rubber access door.
14. Insert the battery, bottom first, into the battery compartment in the back of the MC67.
15. Press the battery down until the battery release latch snaps (two clicks) into place.
16. Replace the handstrap.
17. Warm boot the MC67. See [Resetting the MC67 on page 2-12](#).

Battery Management

Observe the following battery saving tips:

- Leave the MC67 connected to AC power at all times when not in use.
- Set the MC67 to turn off after a short period of non-use.
- Set the backlight to turn off after a short period of non-use.
- Turn off all wireless activities when not in use.

Changing the Power Settings

To set the MC67 to turn off after a short period of non-use:

1. Tap  > **Setting** > **System** > **Power**.
2. Tap the **Advanced** tab.
3. Select the **On battery power: Turn off device if not used for** check box and select a value from the drop-down list.
4. Select **OK**.

Changing the Backlight Settings

To change the backlight settings in order to conserve more battery power:

1. Tap  > **Settings** > **System** > **Backlight** > **Battery Power**.
2. Select the **Disable backlight if device is not used for check box** and select a value from the drop-down list.
3. Select the **Brightness** tab.
4. Tap the **Disable backlight check box** to turn off the display backlight, or use the slider to set a low value for the backlight.
5. Select **OK**.

Changing the Keypad Backlight Settings

To change the keypad backlight settings in order to conserve more battery power:

1. Tap  > **Settings** > **System** > **Keylight** > **Battery Power**.
2. Select the **On battery power: Disable keylight if device if not used for check box** and select a value from the drop-down list.
3. Select the **Advanced** tab.
4. Tap the **Disable keylight check box** to turn off the keypad backlight.
5. Select **OK**.

Turning Off the Radios

The MC67 includes **Wireless Manager**, which provides a simple method of enabling, disabling, and configuring all the MC67's wireless capabilities.

To open **Wireless Manager**, tap  > **Settings** > **Connections** > **Wireless Manager**.

- Tap **All** to toggle all the radios on or off.
- Tap **Phone** to toggle the phone radio on or off.
- Tap **Wi-Fi** to toggle the wireless local area network (WLAN) radio on or off.
- Tap **Bluetooth** to toggle the Bluetooth radio on or off.

Network Activation

Network activation is dependent upon the network type. When an GSM/UTMS SIM card is installed in the MC67ND, upon startup the MC67ND is configured for the GSM/UTMS network.

Activating an MC67ND on a CDMA Network

To activate on a CDMA network:

1. Setup an account with the CDMA carrier. Provide the MEID number (located under the battery of the MC67ND) to the customer service representative.

2. Tap **Start > Settings > Connections > Network Setup & Activation**. The **Network Setup & Activation** window displays.

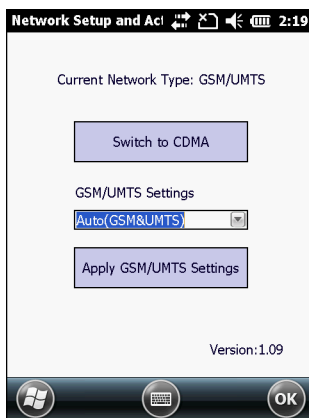

Figure 1-7 Network Setup and Activation Setup Window

3. Tap **Switch to CDMA**.
4. The window closes.
5. Tap **Network Setup & Activation**.
6. Tap **Activation**. The **CDMA Activation** window appears.
7. Tap **Start Activation and PRL Update**.
8. Follow the on-screen instructions.

For detailed information for configuring the phone and activating on a different network, refer to the *MC67 Integrator Guide*.

Switching from CDMA to GSM/UMTS

To switch from a CDMA network to a GSM/UTMAS network:

1. Tap **Start > Settings > Connections > Network Setup & Activation**. The **Network & Activation** window appears.

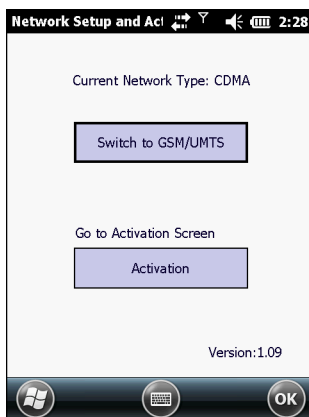

Figure 1-8 Network Setup and Activation Setup Window

2. Tap **Switch to GSM/UMTS**.

3. The window closes.
4. Tap **Network Setup & Activation**.

✓ **NOTE** Switching radio bands may not be available on all networks.

5. In the **GSM/UMTS Settings** drop-down list, select connection type. Options:
 - a. **Auto (GSM&UTMS)**
 - b. **GSM Only**
 - c. **UMTS Only**.
6. Tap **Apply GSM/UMTS Settings**.
7. Tap **OK**.

Switching from GSM/UTMS to CDMA

1. Tap **Start > Settings > Connections > Network Setup & Activation**. The **Network & Activation** window appears.
2. Tap **Switch to CDMA**.
3. The window closes.

CHAPTER 2 USING THE MC67

Introduction

This chapter explains the buttons, status icons, and controls on the MC67, and provides basic instructions for using the MC67, including resetting the MC67 and entering data.

Features

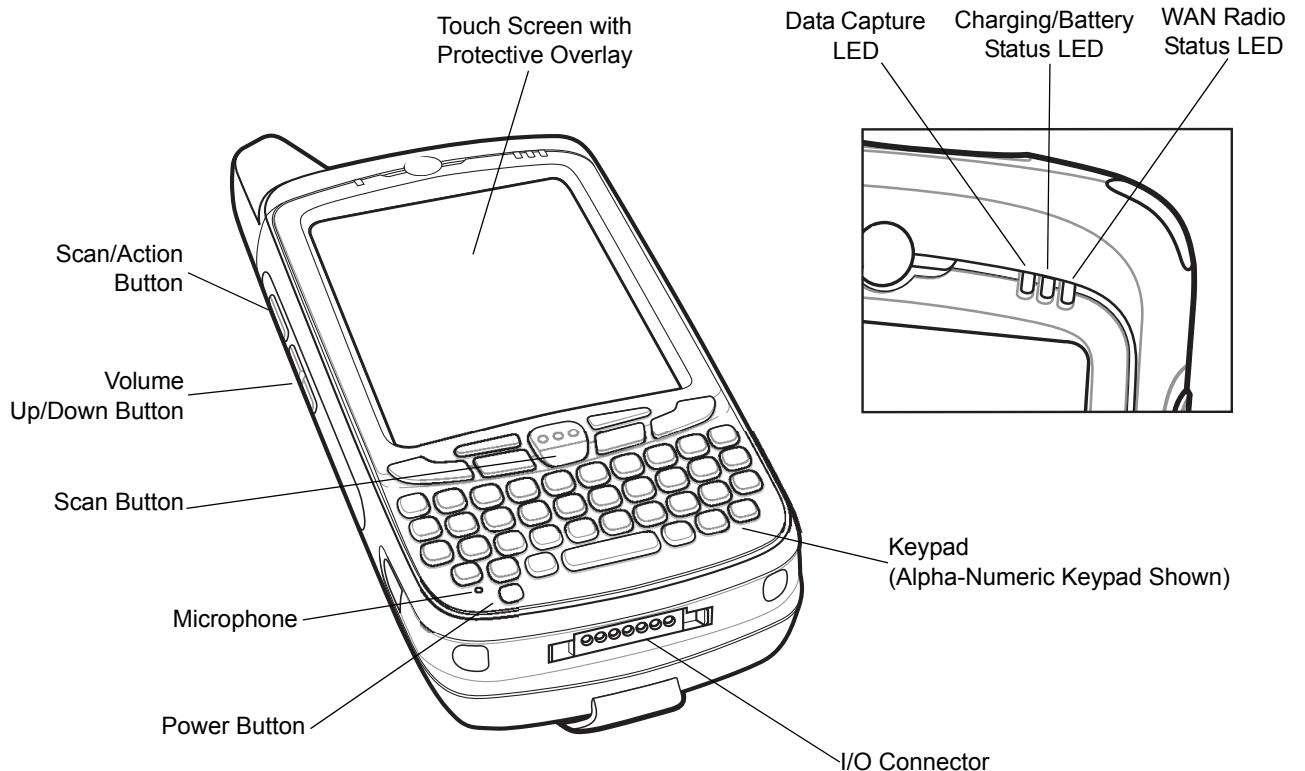

Figure 2-1 MC67 Front View

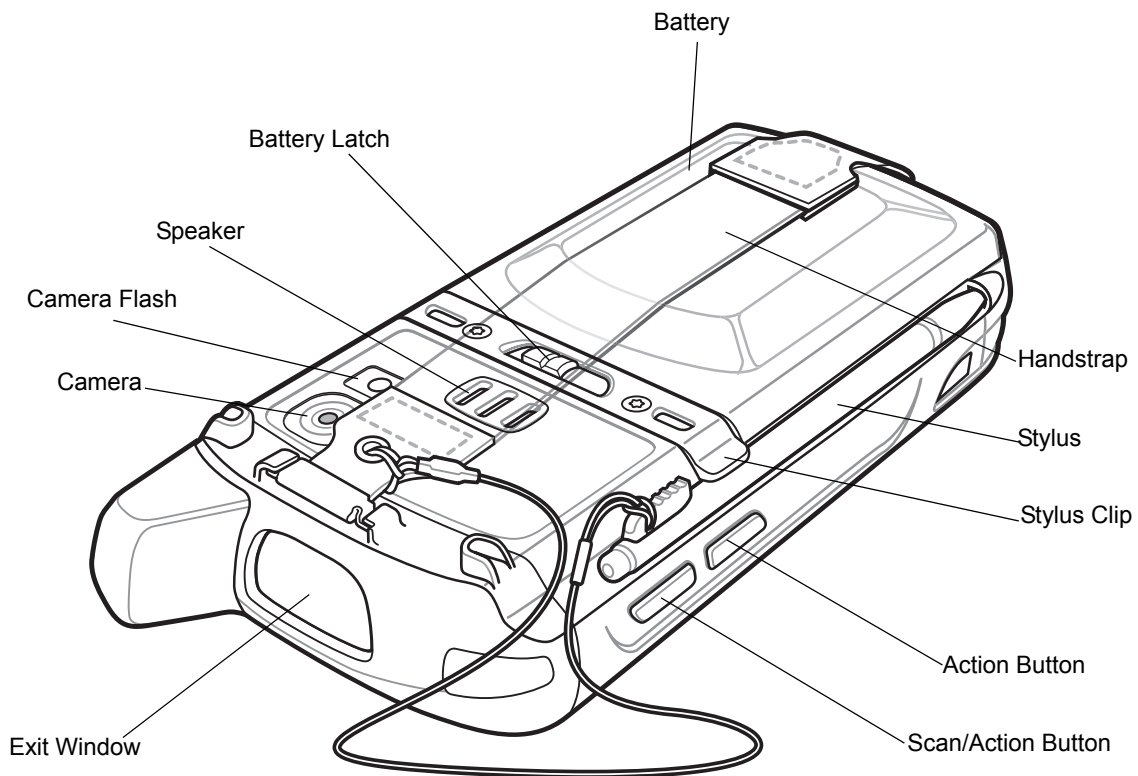

Figure 2-2 MC67 Rear View

LED Indicators

The MC67 has three light emitting diode (LED) indicators. The Data Capture LED indicates status for scanning. The Charging/Battery Status LED indicates battery charging and status. The Radio Status LED indicates Wide Area Network (WAN) radio status. [Table 2-1](#) describes the LED indications.

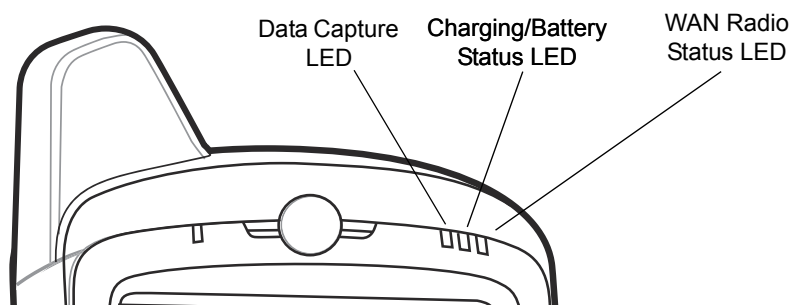

Figure 2-3 LED Indicators

Table 2-1 LED Indications

LED State	Indication
Data Capture LED	
Solid Green	Successful decode/capture.
Solid Red	Data capture in process. Note: Red LED during scanning is disabled on OEM version 03.46.36 and above.
Flashing Green	Software initiated notification.
Solid Red (after Safe Battery Swap mode)	MC67 is shutting down for battery replacement.
Off	Data capture not enabled.
Charging/Battery Status LED	
Slow Blinking Amber	Main battery in MC67 is charging.
Solid Amber	Main battery in MC67 is fully charged.
Fast Blinking Amber	Charging error.
Off	MC67 not charging.
WAN Radio Status LED	
Slow Blinking Green	RF (WAN) radio is on.
Off	RF (WAN) radio is off.



NOTE For information about scanning/decoding, see [Chapter 3, Data Capture](#). For information about WAN radio status and settings, see [Chapter 4, Making Calls](#), or refer to the *MC67 Integrator Guide*.

Keypads

The MC67 offers six keypad configurations: Numeric, QWERTY, AZERTY, QWERTZ, Direct Store Delivery (DSD) and Personal Information Manager (PIM).

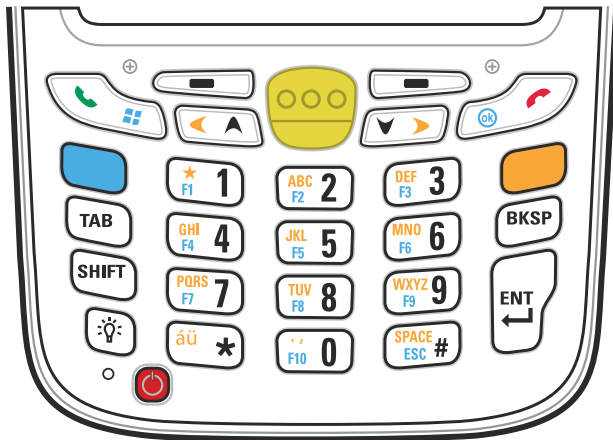

Figure 2-4 MC67 Numeric Keypad

Refer to [Appendix B, Keypads](#) for detailed information on the keypad configurations.

Finger Scrolling

Finger scrolling can be used to scroll up and down web pages, documents, and lists such as the contacts list, file list, message list, calendar appointments list, and more.

When finger scrolling, swipe or flick a finger on the screen.

To scroll down, swipe a finger upward on the screen. To scroll up, swipe a finger downward on the screen.

To auto-scroll, flick a finger upward or downward on the screen. Touch the screen to stop scrolling.

Home Screen

The default home screen on the MC67 is the Windows Embedded Handheld Home screen. The Home screen contains a Status Bar at the top of the screen and a Tile Bar at the bottom of the screen.

The Home screen is scrollable and contains a list of application plug-ins and an Information Status bar. The Information Status bar highlights the application plug-in that is under it and provides additional information.

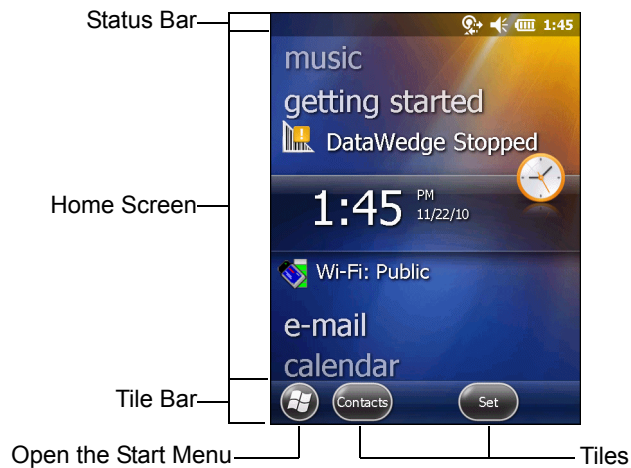

Figure 2-5 Windows Embedded Handheld Home Screen

Touch and hold the screen with a finger and move the Home screen up and down. As the application names move under the Information Status bar, information relevant to that application appear in the bar.

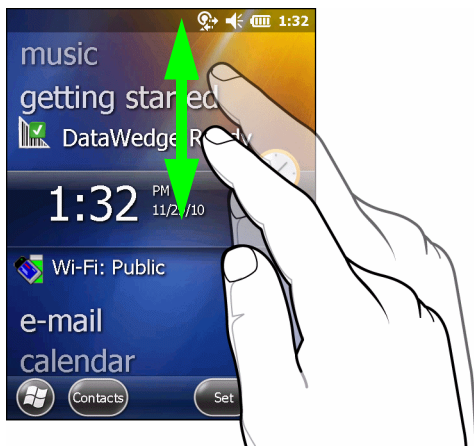

Figure 2-6 Moving Today Screen

Also touch and hold the Information Status bar and move it up and down over an application name. Remove finger and the Information Status bar and application name center in the screen.

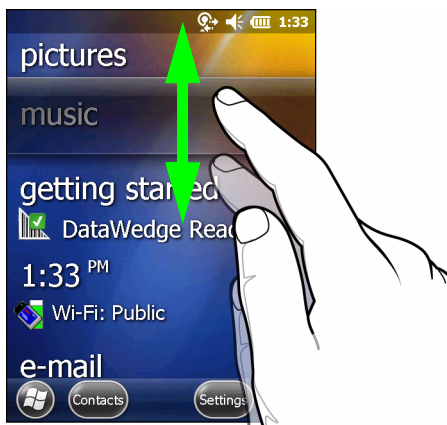

Figure 2-7 Moving Information Status Bar

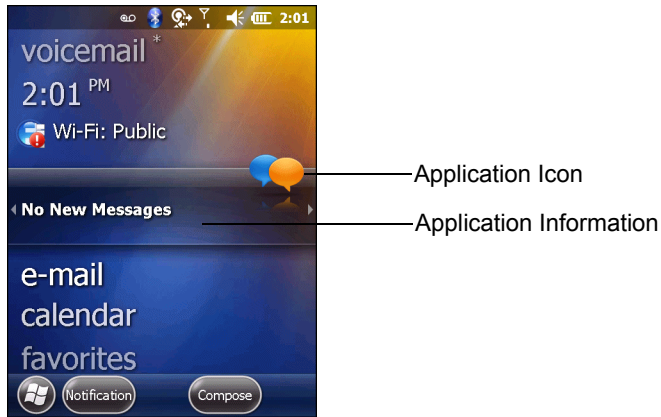

Figure 2-8 Information Bar Example

To customize the **Home** screen, tap > **Settings** > **Today**. On the horizontal scroll, use **Appearance** to customize the background and the **Items** to change the display format.

Classic Today Screen

The user can change to the classic Today screen layout that is used in Windows Mobile 6.1.

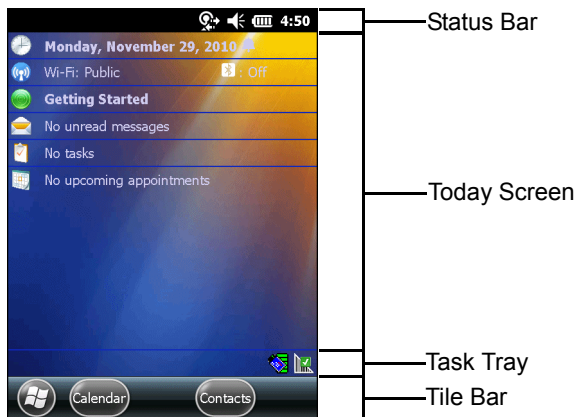

Figure 2-9 Classic Today Screen

To change to the classic view tap > **Settings** > **Home** > **Items**.

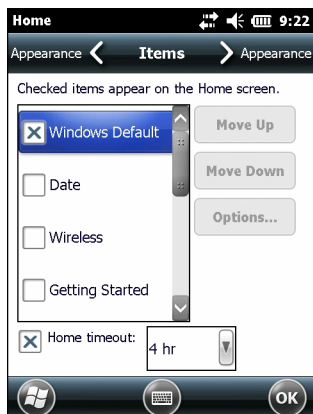





Figure 2-10 Home Screen Settings

Deselect the **Windows Default** checkbox and select any of the other checkboxes.

Tap .

The task bar at the bottom of the screen can contain the task tray icons listed in [Table 2-2](#).

Table 2-2 Task Tray Icons

Icon	Name	Description
	Wireless connection status	Wireless connection status icon. Indicates wireless local area network (WLAN) signal strength and opens the Wireless Applications menu.
	Bluetooth Enabled	The Bluetooth Enabled icon appears in the task tray and indicates that the Bluetooth radio is on (Displays only if the StoneStreet One Bluetooth stack is enabled).
	Bluetooth Disabled	The Bluetooth Disabled icon appears in the task tray and indicates that the Bluetooth radio is off (Displays only if the StoneStreet One Bluetooth stack is enabled).
	Bluetooth Communication	The Bluetooth Communication icon appears in the task tray and indicates that the mobile computer is communicating with another Bluetooth device (Displays only if the StoneStreet One Bluetooth stack is enabled).

Status Bar

The **Status Bar** at the top of the screen displays the status icons listed in [Table 2-3](#).

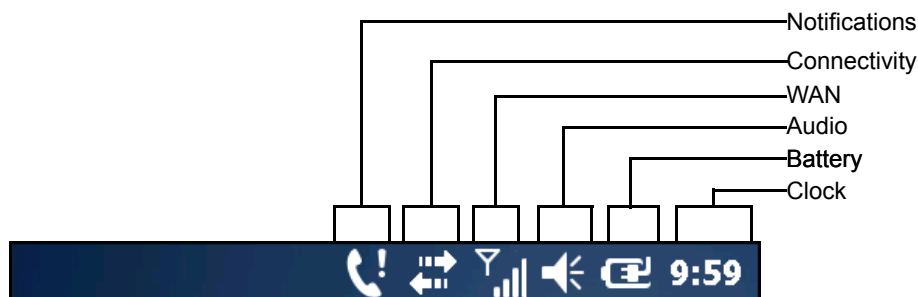

Figure 2-11 Status Bar Icons

Table 2-3 Status Bar Icons















































Icon	Description	Icon	Description
Notifications			
	Reminder of an upcoming calendar event.		One or more instant messages were received.
	One or more text messages were received.		One or more voice messages were received.
	There are more notification icons than can be displayed.		Bluetooth radio is on.

Table 2-3 Status Bar Icons (Continued)











Icon	Description	Icon	Description
	One or more Email messages were received.		Microsoft customer feedback alert.
	Backup battery is low.		
Connectivity			
	Connection is active.		Connection is not active.
	Synchronization is occurring.		wireless fidelity (Wi-Fi) available.
	Wi-Fi in use.		HSPA+ available.
	3G available.		GPRS available.
	EGPRS available.		Roaming.
WAN			
	Call missed.		Dialing while no SIM card is installed.
	Call in progress.		Calls are forwarded.
	Call on hold.		Speakerphone is on.
	Phone on/good signal.		Phone off.
	No WAN service.		Searching for WAN service.
	Evolved High-Speed Packet Access (HSPA+) connecting.		HSPA+ in use.
	3G in use.		3G connecting.
	General Packet Radio Service (GPRS) in use.		GPRS connecting.
	Enhanced General Packet Radio Service (EGPRS) in use.		EGPRS connecting.
	Subscriber identification module (SIM) Card not installed.		
Audio			
	All sounds are on.		All sounds are off.
	Vibrate is on.		
Battery			
	Battery is charging.		Battery has a full charge.
	Battery has a high charge.		Battery has a medium charge.
	Battery has a low charge.		Battery has a very low charge.

Tap the Status Bar to display an icon bar. Tap an icon to get additional notification or status information.



Figure 2-12 *Icon Bar*

Table 2-4 *Task Tray Icons*

Icon	Name	Description
	Magnify	Enlarges the screen.
	Voicemail	Dials Voicemail.
	Missed Call	Opens the Call History window and displays a list of missed calls.
	Low Backup Battery	Indicates that the backup battery is low.
	Notifications	Indicates that notifications are available.
	Headset	Indicates that a wireless stereo headset is connected to the MC67.
	Connectivity	Displays the Connectivity dialog box.
	Phone Data	Displays the Phone dialog box.
	Volume	Displays the Volume dialog box.
	Power	Displays the Power window.
	Clock & Alarms	Opens the Clocks & Alarms window.

Tile Bar

The **Tile Bar**, located at the bottom of the screen, contains the **Start** tile  to open the **Start Menu**. It also displays tiles that vary depending upon the open application.



Figure 2-13 Tile Bar Examples

Table 2-5 Programs Available on the Start Menu























Icon	Description	Icon	Description
	Home - Closes the Start menu and displays the Home screen.		Text - Send an text message.
	Phone - Make calls.		E-mail - Send an Email.
	Contacts - Keep track of friends and colleagues.		Battery Swap - Properly shuts down the MC67 during battery replacement.
	Internet Explorer - Browse Web sites as well as download new programs and files from the Internet.		Settings - Opens the Settings folder. See Chapter 9, Settings for more information.
	Calendar - Keep track of appointments and create meeting requests.		Getting Started - Launch the Getting Started application.
	Pictures & Videos - View and manage pictures and video files.		Alarms - Set the clock to the date and time of the current location. Alarms can also be set at specified days and times of a week.
	Windows Media - Play back audio and video files.		Messenger - Use the mobile version of Windows Live Messenger.
	Marketplace - Purchase applications from the Marketplace.		MSN Weather - Check the local weather.
	MSN Money - Keep track of finances.		Windows Live - Use the mobile version of Windows Live™ to find information on the web.
	Calculator - Perform basic arithmetic and calculations, such as addition, subtraction, multiplication, and division.		Notes - Create handwritten or typed notes, drawings, and voice recordings.
	Games - Play games.		Tasks - Keep track of tasks.

Table 2-5 Programs Available on the Start Menu (Continued)

Icon	Description	Icon	Description
	ActiveSync - Synchronize information between the MC67 and a host computer or the Exchange Server.		File Explorer - Organize and manage files on the device.
	Internet Sharing - Connect a notebook computer to the Internet using the MC67's data connection.		Search Phone - Search contacts, data, and other information on the MC67. Refer to the Microsoft Applications for Windows Mobile 6 User Guide for more information.
	Task Manager - Enables viewing of memory and central processing unit (CPU) allocations and stops running processes.		Help - Access on-line Help topics.
	Wireless Companion - Opens the Wireless Companion folder.		Office Mobile 2010 - Provides access to Excel Mobile, PowerPoint Mobile, OneNote Mobile, SharePoint WorkSpace Mobile and Word Mobile applications.
	Adobe Reader - View pdf files.		BTScanner CtIPanel - Set com port to use with a Bluetooth scanner.
	BTE Explorer - Manages StoneStreet One Bluetooth connections. See Chapter 7, Bluetooth for more information. Appears only if the StoneStreet One Bluetooth stack is enabled.		DEMO - Provides a web link to install Zebra's featured demos for the MC67. After installation, launches the demo application.
	MSP Agent - Enables management of the MC67 from an Mobility Services Platform (MSP) Server. Requires the purchase of an appropriate MSP client license per device to suit the level of management functionality required.		MotoBTUI - Use to set Bluetooth options and configuration.
	Rapid Deployment Client - Allows the MC67 user to stage a device for initial use by initiating the deployment of settings, firmware, and software. Requires the purchase of an Mobility Services Platform (MSP) client license per device.		RTlogEvent - Use when instructed by Zebra support personnel.
	Remote Desktop Mobile - Log onto Windows NT server type computers and use all of the programs that are available on that computer from the MC67.		SIM ToolKit - Manage the contacts that are stored on the SIM card. Copy SIM contents to Contacts ion the device.
	SMS Staging - Receives and processes SMS messages from an MSP Server and allows the user to stage an MC67 based on them. Requires the purchase of an MSP client license per device.		

Adjusting Volume

To adjust the system volume:

1. Press the volume buttons on the right side of the MC67 to increase and decrease the system volume. The **Volume** dialog box appears.
2. As the user increases or decreases the volume, the slider moves accordingly. The user can also move the slider to adjust the volume.
3. Select the **Vibrate** radio button to turn off the system audio and enable the MC67 to vibrate upon system notifications.
4. Select **Off** radio button to turn off all system audio notifications.

Resetting the MC67

There are two reset functions, warm boot and cold boot. A warm boot restarts the MC67 by closing all running programs. A cold boot also restarts the MC67, and also initializes some drivers. Data saved in flash memory or a memory card is not lost.







If the MC67 is not functioning properly, perform a warm boot first. If the MC67 still does not respond, perform a cold boot.

Performing a Warm Boot

Hold down the red **Power** button for approximately five seconds. As soon as the MC67 starts to boot (splash screen displays) release the **Power** button.



Performing a Cold Boot

To perform a cold boot:

- On a numeric or DSD keypad, simultaneously press the red **Power** button and the  and  keys.
- On an alphanumeric keypad, simultaneously press the red **Power** button and the  and  keys.
- On an PIM keypad, simultaneously press the red **Power** button and the  and  keys.

Locking the MC67

Locking the MC67 turns off keyboard and touch screen functionality. This is helpful when the MC67 is turned on and to prevent accidental key presses.

To lock the MC67, tap  > .

To unlock the MC67, side the **Lock** button to the left or right.

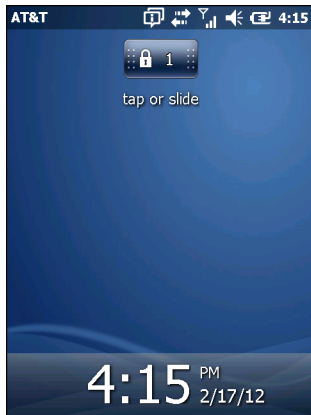

Figure 2-14 *Unlock Device Window*

If the MC67 was locked with a PIN or password, a prompt appears.

Un-locking with Simple PIN

When the MC67 is locked, the **Lock** screen appears.

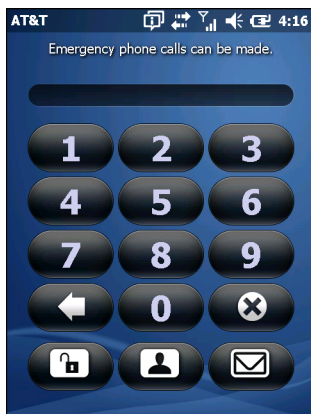

Figure 2-15 *Simple PIN Lock Screen*

Enter the password to un-lock the device.

Tap the **Unlock** button to unlock the device and go to the Home screen, or tap the **Contact** button to unlock the device and go to the Contacts window or tap the **Email** button to unlock the device and go to the **Messaging** window.

Un-locking with Strong Password

When the MC67 is locked, the **Lock** screen appears.

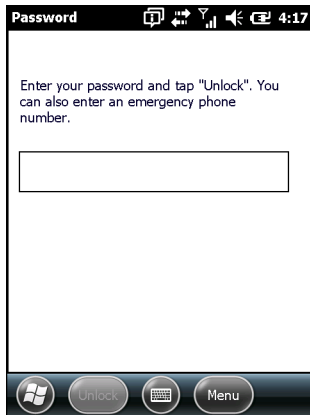

Figure 2-16 Strong Password Lock Screen

Enter the strong password and then tap **Unlock**.



NOTE If the user enters an incorrect password eight times, the user is requested to enter a code before trying again.

If the user forgets the password, contact the system administrator.

Battery Status Indications

Battery icons appear on the Status bar indicating the battery power level. When the main battery power falls below a predetermined level the icon indicates the status and a battery dialog box appears indicating the status of the battery. When the backup battery is low an icon appears in the Status bar and a battery dialog box appears indicating the status of the backup battery.

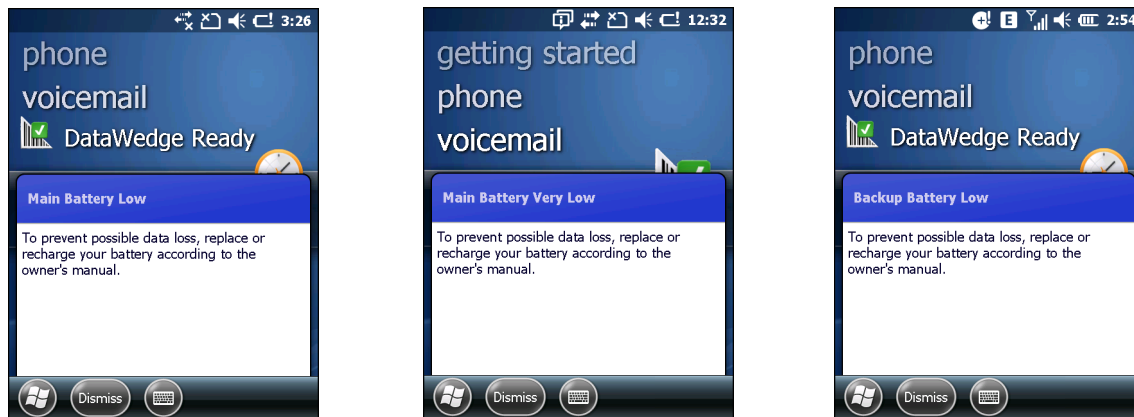



Figure 2-17 Battery Status Dialog Boxes

The **Battery** icon always appears in the **Status bar**. The icon indicates the battery power level. The message displays until the **Dismiss** button is pressed.

Also view the battery status using the **Power** window. Either:

- Tap the Status bar and then the **Battery** icon.
- Tap  > **Settings** > **System** > **Power**.

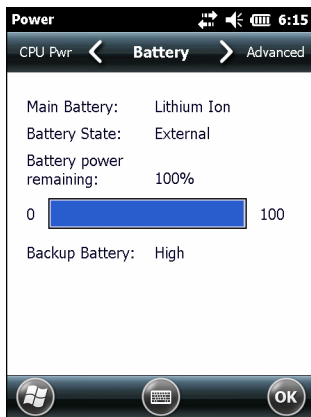

Figure 2-18 Settings Power Window

Battery Reserve Options

If the charge of the battery reaches a critical threshold, the MC67 shuts down. This threshold can be changed but affects the amount of time that data can be retained.

1. Tap > **Settings** > **System** > **Power** > **RunTime**. A warning message appears.

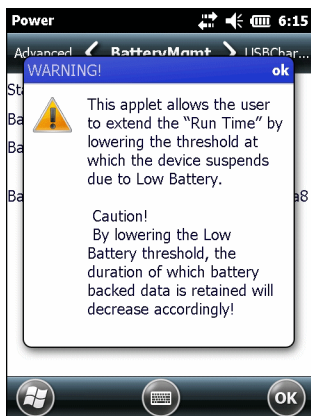

Figure 2-19 Warning Message

2. Read the warning message and tap **OK**.

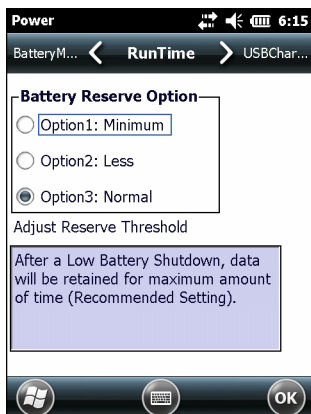

Figure 2-20 RunTime Tab

3. Select one of the **Battery Reserve Options**.

- **Option 1: Minimum** - After a low battery shutdown, data will be retained for minimum amount of time. Battery should be replaced immediately to avoid data loss.
- **Option 2: Less** - After a low battery shutdown, data will be retained for less than normal amount of time.
- **Option 3: Normal** - After a low battery shutdown, data will be retained for maximum amount of time.

4. Tap **OK**.

Main Battery Temperature Notifications

The temperature notification system implements three levels of notification when the temperature within the battery exceeds specific temperature thresholds:

- **Level 1: Temperature Watch**; this level is similar to main battery low warning. It indicates that the battery temperature has reached the first threshold level. The user should move to an environment within proper operating temperature.
- **Level 2: Temperature Warning**; this level is similar to main battery very low warning. It indicates the battery temperature has reached the second threshold level. The user should close all running applications and stop using the MC67.
- **Level 3: Temperature Error**; this level indicates the battery has reached an unusable temperature threshold and immediately suspends the MC67. This level does not have any graphical notification associated with it.

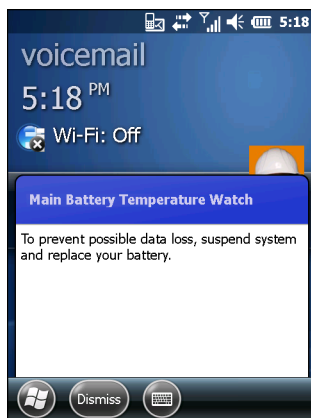

Figure 2-21 Main Battery Temperature Watch Dialog Box

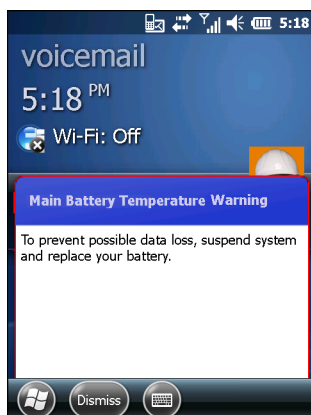

Figure 2-22 Main Battery Temperature Warning Dialog Box



NOTE The **Temperature Warning** dialog box remains visible until the user taps **Hide**.

Interactive Sensor Technology

The Interactive Sensor Technology (IST) supports the following features:

- **Power Management** – manages power by configuring IST to control switching on/off the backlight, control suspend mode of the MC67 by monitoring motion and orientation.
- **Display Orientation** – switches the screen orientation to either landscape or portrait depending on the MC67 orientation.
- **Free Fall Detection** – monitors free fall duration and records the time and type of the drop event.

The MC67 is equipped with sophisticated and powerful sensors to sense and react to environmental changes, motion, orientation and user input. These sensors include accelerometer, magnetometer, gyroscope, ambient light sensor, near range sensor, temperature sensor and proximity sensor.

The accelerometer and gyroscope measure the linear acceleration and angular velocity. The magnetometer measures the magnetic field intensity experienced by the MC67. This information can be used to derive the motion state and the orientation of the device. For example, an MC67 can automatically rotate the display from portrait to landscape mode to match the device orientation, enter suspend mode or switch off backlight to save power when display is placed face down.

The ambient light sensor detects the intensity of light on or around the display screen. The MC67 can adjust the screen brightness for optimum visibility while conserving power.

The near range proximity sensor detects any object in close proximity to device. This information can be used to disable the touch pad when the caller's face is close to the device to prevent unintended key press.

See [IST Settings on page 9-8](#) for more information.

Power Management

The MC67 orientation and motion sensitive data can be used as an indicator of MC67 usage and can be used to manage the battery power of the mobile computer. For example, IST can be configured to control the backlight on and off functionality or go into suspend according to a user gesture by placing screen facing down. It can also be used to keep the MC67 active while it is in movement to prevent it from quickly going into suspend mode while in use.

Display Orientation

The screen can be rotated between portrait and landscape modes automatically, depending on the physical orientation of the MC67. For example, if the MC67 is rotated 90° counterclockwise, IST rotates the display counterclockwise 90° so that the screen display appears correct.

This functionality is achieved by monitoring screen angle and rotating the display to counter any changes. IST only rotates the screen in multiples of 90°.

Free Fall Detection

IST continuously monitors gravitational force on the MC67 according to its current position. When the MC67 free falls, IST detects the absence of gravitational force and records the event data if it detects a free fall more

than 450 ms, which may indicate nearly a one meter drop. This data can be used as an indicator of potential abuse or misuse.

Stylus

Use the MC67 stylus to select items and enter information. The stylus functions as a mouse.

- Tap: Touch the screen once with the stylus to press option buttons and open menu items.
- Tap and Hold: Tap and hold the stylus on an item to see a list of actions available for that item. On the pop-up menu that appears, tap the action to perform.
- Drag: Hold the stylus on the screen and drag across the screen to select text and images. Drag in a list to select multiple items.



CAUTION To prevent damage to the screen, do not use any device other than the Zebra-provided stylus.

Entering Data

When entering data on the keypad, use either the single-hand method or the two-hand method as shown in [Figure 2-23](#).

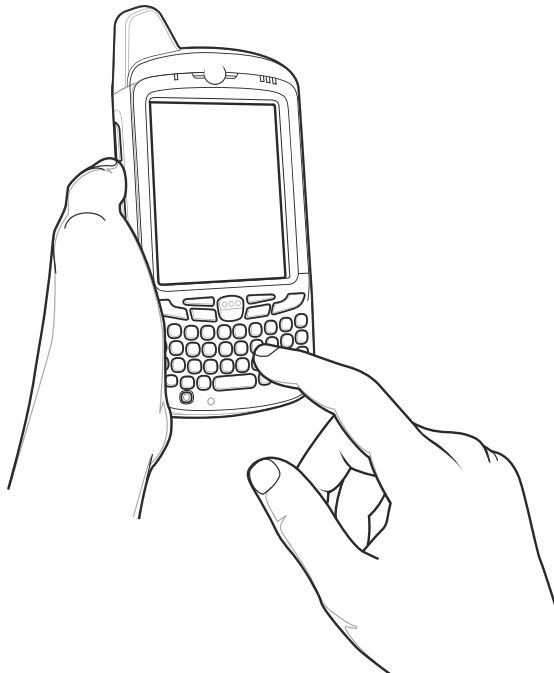

Single-hand Method

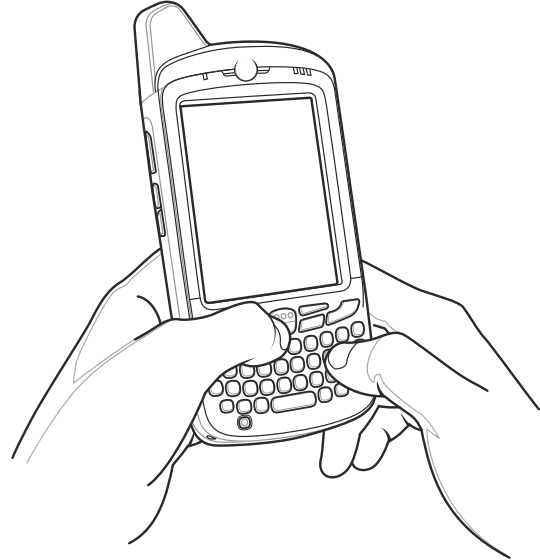

Two-hand Method

Figure 2-23 *Entering Data on the Keypad*

Using Voice-Over-IP

The MC67 supports Voice over IP over WLAN (VoWLAN) using third party voice clients. The MC67 can communicate using VoIP either using the MC67 supports several audio outputs, including back speaker phone, front receiver or handset, and Bluetooth headset.

It is recommended that the wireless network use the 802.11a (5 GHz) band for voice applications. Using the 5 GHz band avoids some noise sources that may occur on the 802.11b/g (2.4 GHz) band due to wireless interference.

When using a Bluetooth headset with the MC67 and VoWLAN, it is required to use the Bluetooth Headset profile instead of Hands-free profile. Use the buttons on the MC67 to answer and end calls. See [Chapter 7, Bluetooth](#) for information on setting up a Bluetooth Headset Profile.

CHAPTER 3 DATA CAPTURE

Introduction

The MC67 offers three types of data capture options:

- Imaging
- Digital camera
- RS507 Hands-free imager.

Imaging

The MC67 with an integrated imager has the following features:

- Omnidirectional reading of a variety of bar code symbologies, including the most popular linear, postal, PDF417, and 2D matrix code types.
- The ability to capture and download images to a host for a variety of imaging applications.
- Advanced intuitive laser aiming cross-hair and dot aiming for easy point-and-shoot operation.

The imager uses imaging technology to take a picture of a bar code, stores the resulting image in its memory, and executes state-of-the-art software decoding algorithms to extract the bar code data from the image.

Operational Modes

The MC67 with an integrated imager supports three modes of operation, listed below. Activate each mode by pressing the **Scan** button.

- **Decode Mode:** In this mode, the MC67 attempts to locate and decode enabled bar codes within its field of view. The imager remains in this mode as long as the user holds the scan button, or until it decodes a bar code.



NOTE To enable Pick List Mode, configure in DataWedge or set in an application using a API command.

- **Pick List Mode:** This mode allows the user to selectively decode a bar code when more than one bar code is in the MC67's field of view. To accomplish this, move the aiming crosshair or dot over the required bar code to decode only this bar code. This feature is ideal for pick lists containing multiple bar codes and manufacturing or transport labels containing more than one bar code type (either 1D or 2D).
- **Image Capture Mode:** Use this mode to capture an image within the MC67's field of view. This is useful for capturing signatures or images of items like damaged boxes.

Digital Camera

The MC67 with an integrated camera based bar code scanning solution has the following features:

- Omnidirectional reading of a variety of bar code symbologies, including the most popular linear, postal, PDF417, and 2D matrix code types.
- Advanced intuitive aiming for easy point-and-shoot operation
- Taking photos and recording videos.

The solution uses the advanced camera technology to take a digital picture of a bar code, and executes state-of-the-art software decoding algorithms to extract the data from the image.

Scanning Considerations

Typically, scanning is a simple matter of aim, scan, and decode and a few quick trial efforts master it. However, consider the following to optimize scanning performance:

- **Range**
Any scanning device decodes well over a particular working range — minimum and maximum distances from the bar code. This range varies according to bar code density and scanning device optics.
Scanning within range brings quick and constant decodes; scanning too close or too far away prevents decodes. Move the scanner closer and further away to find the right working range for the bar codes being scanned.
- **Angle**
Scanning angle is important for promoting quick decodes. When laser beams reflect directly back into the scanner from the bar code, this specular reflection can “blind” the scanner.
To avoid this, scan the bar code so that the beam does not bounce directly back. But don't scan at too sharp an angle; the scanner needs to collect scattered reflections from the scan to make a successful decode. Practice quickly shows what tolerances to work within.
- Hold the MC67 farther away for larger symbols.
- Move the MC67 closer for symbols with bars that are close together.



NOTE Scanning procedures depend on the application and MC67 configuration. An application may use different scanning procedures from the one listed above.

Imager Scanning

To read a bar code, a scan-enabled application is required. The MC67 contains the **DataWedge** application that allows the user to enable the imager, decode the bar code data and display the bar code content.

1. Enable **DataWedge**. See [Enable DataWedge on page 3-5](#).
2. Launch an application that supports text inputs, such as **Word Mobile 2010** or **Excel Mobile 2010**.
3. Point the exit window on the top of the MC67 at a bar code.

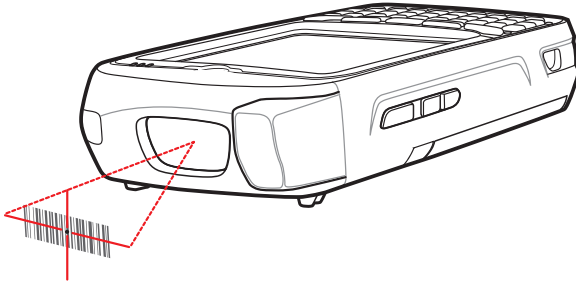

Figure 3-1 Imager Scanning

4. Press and hold the scan button.

The red laser aiming pattern turns on to assist in aiming. Ensure the bar code is within the area formed by the crosshairs in the aiming pattern. The aiming dot is used for increased visibility in bright lighting conditions.

✓ **NOTE** On OEM version 03.46.36 and above, the red LED does not light during scanning.

The Scan/Decode LED lights red to indicate that scanning is in process, then lights green and a beep sounds, by default, to indicate the bar code was decoded successfully. Note that when the MC67 is in Pick List Mode, the imager does not decode the bar code until the crosshair or aiming dot touches the bar code.



Figure 3-2 Aiming Pattern

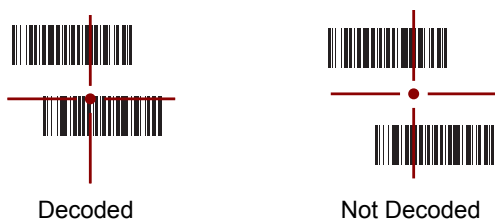

Figure 3-3 Pick List Mode with Multiple Bar Codes in Aiming Pattern

5. Release the scan button.

- ✓ **NOTE** Imager decoding usually occurs instantaneously. The MC67 repeats the steps required to take a digital picture (image) of a poor or difficult bar code as long as the scan button remains pressed.

6. Disable **DataWedge**. See [Disable DataWedge on page 3-5](#).

Digital Camera Scanning

To read a bar code, a scan-enabled application is required. The MC67 contains the **DataWedge** application that allows the user to enable the camera, decode the bar code data and display the bar code content.

1. Enable **DataWedge**. See [Enable DataWedge on page 3-5](#).
2. Launch an application that supports text inputs, such as **Word Mobile 2010** or **Excel Mobile 2010**.
3. Point the camera lens on the back of the MC67 at a bar code.



Figure 3-4 Camera Scanning

- ✓ **NOTE** On OEM version 03.46.36 and above, the red LED does not light during scanning.

4. Press and hold . A preview window appears on the display window and a red aiming line emits from the MC67. The Data Capture LED lights red indicating that the data capture is in process.
5. Move the MC67 until the red aiming line is across the bar code.
6. The light emitting diode (LED) lights green and a beep sounds, by default, to indicate the bar code was decoded successfully.
7. The bar code content data displays in the text field.

Using the RS507 Hands-free Imager

An RS507 Hands-free Imager can be used with the MC67 to capture bar code data.

- ✓ **NOTE** Only one RS507 can be paired with the MC67 at a time.

To set up the RS507:

1. Tap **Start > BTScannerCtlPanel**.
2. If required, select the **BT Scanner** checkbox and then select the appropriate Com port from the drop-down list.
3. Tap **Save and Exit**.
4. Tap **Start > MotoBTUI**.
5. Tap **Pairing Barcode**. A bar code displays.
6. Point the RS507 at the bar code. The RS507 reads the bar code and begins pairing with the MC67.

Refer to the *RS507 Hands-free Imager Product Reference Guide* for more information.

DataWedge

Enable DataWedge

To enable DataWedge:

1. Tap  > **Settings > System > DataWedge**.
2. Tap **Basic configuration**.
3. Tap **1. Barcode input**.
4. Tap one of the following:
 - a. **1. Block Buster Imager** (for scanning using the imager).
 - b. **2. Camera Scanner Driver** (for scanning using the camera).
 - c. **3. Bluetooth SSI Scanner Driver** (for scanning using the RS507, see [Using the RS507 Hands-free Imager on page 10-19](#)).
5. Ensure that a check mark is next to **1. Enabled**. If not, tap **1. Enabled**.
6. Tap **0. Back**.
7. Tap **0. Back**.
8. Tap **0. Exit** and then tap **OK**.
9. Tap **Running** to start the DataWedge process. The DataWedge Status changes to **Ready**.
10. Tap **OK**.

Disable DataWedge

To disable DataWedge:

1. Tap  > **Settings > System > DataWedge**.
2. Tap the **Running** option to end the DataWedge process. The DataWedge Status changes to **Stopped**.
3. Tap **OK**.

Taking Pictures

To take a picture:

1. Tap  > **Pictures & Videos**.
2. Tap **Camera**.



Figure 3-5 *Camera Window*

The Camera window displays the view finder. Information about the current settings or the remaining number of pictures that can be saved to the MC67 are displayed on the lower right corner of the screen.

3. Check the image on the view finder, adjust if necessary.
4. Press the **Enter** key to take the picture.

Burst Mode

Burst mode is a way to take a series of quick pictures.

1. Tap  > **Pictures & Videos**.
2. Tap **Camera**.
3. Tap **Menu > Mode > Burst**.
4. Check the image on the view finder, adjust if necessary.
5. Press the **Enter** key to take the picture.

To stop a burst of pictures before all pictures have been taken tap **OK**.

Timer Mode

To take pictures using the timer:

1. Tap  > **Pictures & Videos**.
2. Tap **Camera**.

3. Tap **Menu > Mode > Timer**.



NOTE By default, the self timer delay is set at five seconds.

4. Check the image on the view finder, adjust if necessary.
5. Press the **Enter** key to take the picture.

Editing Pictures

Rotate, crop, zoom, and adjust the brightness and color contrast pictures.

1. Tap  > **Pictures & Videos**.
2. Tap the thumbnail of the picture to view.
3. Tap **Menu > Zoom** to display the Zoom panel, used to zoom in or out of a picture. Tap **Menu > Zoom** again to close the Zoom panel.
4. To rotate a picture 90 degrees counter-clockwise, tap **Menu > Edit**, then tap **Rotate**.
5. To crop a picture, tap **Menu > Edit**, then tap **Menu > Crop**. Drag the stylus across the screen to select the crop area. Tap inside the area to crop the picture, or outside of the area to cancel cropping.

Setting a Picture as Wallpaper

To add a custom look to the Home screen of the MC67 (using the Windows Home screen); apply a wallpaper using any image. To set an image as a Home wallpaper:

1. Tap and hold a thumbnail, then select **Set as Home Background**.
2. Tap the up or down arrows to set the transparency level.
3. Tap **OK**.

Camera Configuration

To configure the camera settings:

1. Tap  > **Pictures & Videos**.
2. Tap **Menu**, then configure the device settings.
 - **Video** - Tap to switch to video mode.
 - **Mode** - Select from the following modes to take the picture:
 - **Normal** - Takes picture using the default settings.
 - **Burst** - Takes picture consecutively in continuous mode.
 - **Timer** - Takes picture five seconds after pressing the **Enter** key.
 - **Brightness** - Set the camera brightness level.
 - **Resolution** - Set the camera resolution level. Note that selecting a high resolution picture increases the size of the file significantly.
 - **Flash** - Turns flash on and off.
 - **Auto Focus** - Turns auto focus on and off.

- **Full Screen** - Toggles the viewfinder between full screen and window modes.
 - **Options** - Displays the camera options window.
3. Tap **OK** to exit.

Recording a Video

To record a video:

1. Tap  > **Pictures & Videos**.
2. Tap **Camera**.
3. Tap **Menu > Video**.



Figure 3-6 Video Window

The available recording time displays on the screen.

✓ **NOTE** By default, the time limit for recording videos is set to 30 seconds.

4. Press the **Enter** key to begin recording.
5. Press the **Enter** key to stop recording.

Video Configuration

To configure the video settings:

1. Launch the **Video** application.
2. Tap **Menu**, then configure the device settings.
 - **Still** - Tap to switch to still (camera) mode.
 - **Brightness** - Set the video brightness level.
 - **Quality** - Set the quality (video resolution and sound fidelity) and size of the video clips. Video clips of higher quality require more memory.
 - **Full Screen** - Toggles the viewfinder between full screen and window modes.
 - **Options** - Displays the video options window.

3. Tap **OK** to exit.

Viewing Pictures and Videos

To view a picture or video:

1. Tap  > **Pictures & Videos**.
2. Tap the thumbnail of the picture or video:
 - Tap the **Show** drop-down list to browse folders.
 - Tap the **Sort By** drop-down list to sort the files by name, date or size.

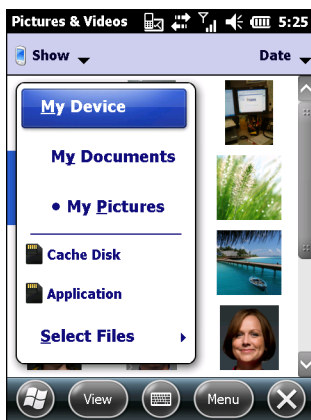

Figure 3-7 *Pictures & Videos*

Customizing Pictures & Videos

Using the **Options** command to set preference settings on how to use **Pictures & Videos**.

To customize **Pictures & Videos**:

1. On either thumbnail or full screen mode, tap **Menu** > **Options**.
2. On the **General** tab, set the following options:
 - Select the size of the pictures to send through e-mail. Only pictures sent through an e-mail message is resized, the original picture remains unchanged.
 - Resize pictures for faster e-mail transfer.
 - Rotate pictures towards left or right.
3. On the **Slide Show** tab, set the following options:
 - Select the **Portrait pictures** or **Landscape pictures** radio button to set slide show orientation.
 - Select the **Play a screen saver when connected to my PC and idle for 2 minutes** check box to set the image files in the **My Pictures** folder as a screen saver whenever the device is connected to the USB sync cable and is idle for 2 minutes.
4. On the **Camera** tab, set the following options:
 - In the **Type filename prefix** text box, enter the prefix to be used as a default title for the image file.

- In the **Save files to** drop-down list, select to save image files to onboard memory or built-in storage.
 - In the **Still image compression level** drop-down list, set a compression level when saving the image. The high quality setting provides the best image quality but more memory is required.
5. On the **Video** tab, set the following options:
- Select the **Include audio when recording video files** check box to record audio along with video.
 - In the **Time limit for videos** drop-down list, set the amount of time for recording video.

CHAPTER 4 MAKING CALLS

Introduction

Use the MC67 to make phone calls, keep track of calls, and send text messages. Wireless service providers may also provide other services such as voice mail, call forwarding, and caller ID.

Also use the phone to connect to an Internet Service Provider (ISP) or work network in order to browse the Web and read e-mail over Evolved High-Speed Packet Access (HSPA+) or CDMA Evolution Data Optimized (EvDO) using cellular line.



Making a Call

- ✓ **NOTE** The user can make emergency calls even when the MC67 is locked or when a subscriber identification module (SIM) card is not installed. See [Emergency Calling on page 4-5](#) for more information.

With the MC67, make a call from the phone, contacts, speed dial and call history.

Using the Phone Keypad

To make a call using the phone keypad:

1. Press .
2. Enter the phone number on the dialer or keypad. The number appears in the call line.
3. Press .
4. Press  to stop dialing or end the call.

- ✓ **NOTE** If the user taps a wrong number, tap Delete key to erase each subsequent digit of a number. To erase the entire number, tap and hold the Delete key.

Smart Dialing

Smart Dialing makes it easy to dial a phone number. When the user starts entering numbers or characters, Smart Dialing automatically searches and sorts the contact entries on the SIM card, in Contacts, and the phone numbers in Call History (including incoming, outgoing, and missed calls). The user can then select the desired number or contact from the filtered list to dial.

Open the Phone screen, then tap the keys on the Phone keypad that correspond to the phone number or contact to call. The contact panel lists contacts that match the sequence entered.

Smart Dialing starts looking for numbers or contacts that match the sequence entered.

To find a phone number:

- Enter the first one or two digits to find a phone number in Call History.
- Enter the first three digits or more to find a phone number from the saved Contacts and SIM card.

To find a contact name:

- Enter the first letter of a contact's first name or last name. Smart Dialing searches for the letter starting from the first character of a contact name as well as from the character that appears after a space, dash, or underscore in a contact name. For example, if the user taps number "2" which is associated with [a, b, c] on the Phone keypad, contact names such as the following will be considered matches: "Smith, Bernard", "Adams, John", "Carlson, Eileen", "Dillon, Albert", "Childs, Larry", "Cooper, Robert" and "Parks, Celine".
- If the matching list is long narrow down the search further by entering another letter. Using the same example above, tap "3" which is associated with (d, e, f), the matching list is narrowed down to the following names: "Smith, Bernard", "Adams, John", and "Parks, Celine".



Figure 4-1 Finding a Contact

To make a call or send a text message using Smart Dialing:

1. Begin entering the first few numbers or characters.
2. In the Smart Dialing panel, use the up and down arrows on the keypad to navigate to the desired contact or phone number.
3. When the correct contact is selected, press **TALK** to make a voice call.
4. To send a text message to the selected contact, tap  > **Send Text Message**.
5. To call a different phone number associated with the selected contact, tap the contact name and select the phone number to call.

Using Contacts

Use Contacts to make a call without looking up or entering the phone number.

To make a call from Contacts:

1. Tap **Contacts**.
2. From the contact list, tap and hold the contact name.

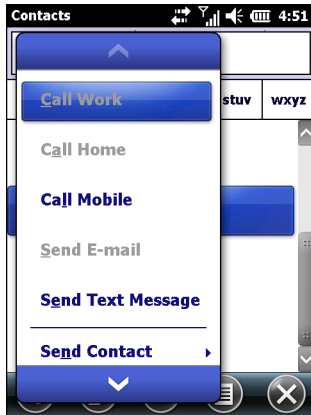



Figure 4-2 Contacts Menu

3. Tap **Call Work**, **Call Home** or **Call Mobile**.

✓ **NOTE** To make a call from an open contact, tap the number to call. See On-Device Help for more information about Contacts.

Using Call History

To make a call using Call History:

1. Press .
2. From the Phone keypad, tap **Call History**.

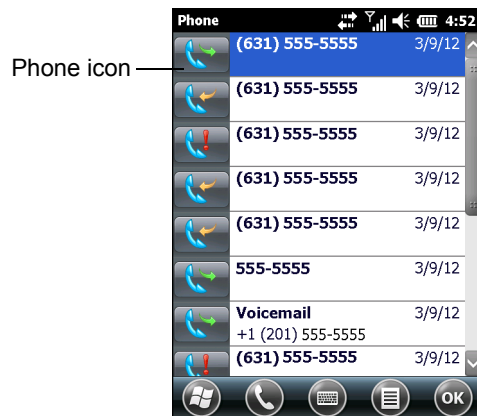

Figure 4-3 Call History Window

3. Tap the phone icon next to the number to begin dialing and return to the phone keypad.

- Tap **End** or press the red phone key on the MC67 keypad to stop dialing or end the call.

Making a Speed Dial Call

Use Speed Dial to call someone saved in the speed dial directory.

To make a speed dial call:

- Press .
- From the keypad, tap and hold the speed dial location number assigned to a contact. (To dial a one-digit speed dial location number, tap and hold the speed dial number. To dial a two-digit speed dial location number, tap the first digit and then tap and hold the second digit.)

or

From the keypad, tap **Speed Dial** and tap the speed dial location number of the desired contact in the list.

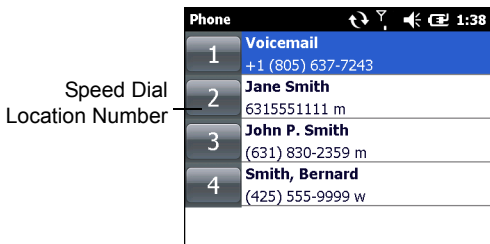



Figure 4-4 Speed Dial Contact List

- To stop dialing or end the call, press .

Answering a Call

A dialog box appears on the MC67 when it receives an incoming call. If the phone is set to ring, a ring tone sounds. Answer or ignore the incoming call.

To answer an incoming call tap **Answer** on the dialog box or press .

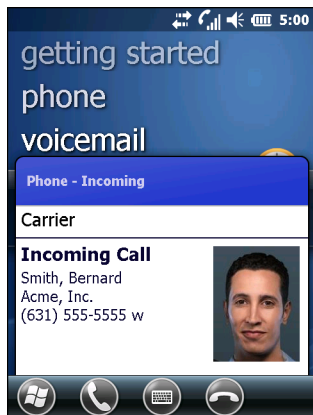









Figure 4-5 Incoming Call

To ignore the incoming call tap  or press . This sends the caller to voice mail, depending on the service provider. Otherwise, this presents a busy signal to the calling party.

To end the call press .

Incoming Call Features

- The user can use other programs on the MC67 during a call. To switch back to the phone, press . Press  to end the call.
- To hold the current call and answer a waiting call, tap **Answer** to place the current call on hold and answer the incoming call.
- Press  to put a call on hold to call another number.
- To move from one call to another, press .

Missed Call Notification

When the user does not answer an incoming call, the Home screen displays a **Missed Call** indication.

To display a missed call entry tap the **Missed Call** box on the **Home** screen.

Emergency Calling

The service provider programs one or more emergency phone numbers, such as 911 or 999, that the user can call under any circumstances, even when the phone is locked, a SIM card is not inserted or the phone is not activated. The service provider can program additional emergency numbers into the SIM card. However, the SIM card must be inserted in the MC67 in order to use the numbers stored on it. See the service provider for additional information.

- ✓ **NOTE** Emergency numbers vary by country. The phone's pre-programmed emergency number(s) may not work in all locations, and sometimes an emergency call cannot be placed due to network, environmental, or interference issues.

Audio Modes

The MC67 offers three audio modes for use during phone calls:

- **Handset Mode:** Switches audio to the speaker at the top front of the MC67, so The user can use the MC67 as a handset. This is the default mode.
- **Speaker Mode:** Use the MC67 as if on speaker phone. Tap the **Speaker On** button to activate this mode. Tap the **Speaker Off** button to switch back to handset mode.
- **Headset Mode:** Connect a Bluetooth headset to automatically switch audio to the headset.

The MC67 defaults to handset mode.

Using a Bluetooth Headset

Use a Bluetooth headset for audio communication when using an audio-enabled application. See [Chapter 7, Bluetooth](#) for information on connecting a Bluetooth headset to the MC67. Set the MC67's volume

appropriately before putting the headset on. When a Bluetooth headset is connected the speakerphone is muted.

Adjusting Audio Volume

Use the Volume buttons to adjust the volume of the ringer when not in a call and the audio volume when in a call.

- ✓ **NOTE** Adjust the conversation phone volume during a call. Adjusting the volume while not in a call affects the ring and notification sound levels.

Muting a Call

During a call, the caller can mute the microphone so they can hear the person on the line but cannot hear the caller. This is useful when there is conversation or background noise.

To mute or unmute a call tap **Mute** on the dialer to mute the audio. The **Mute** button becomes yellow.

Taking Notes

To create a note during a call, tap **Note** on the display, then enter the note. For more information about creating notes see the Windows On-Device Help.

To access a note created during a call:

1. Press .
2. From the Phone keypad, tap **Call History**.
3. Tap and hold the number or the **Note** icon for the phone call entry containing the note.

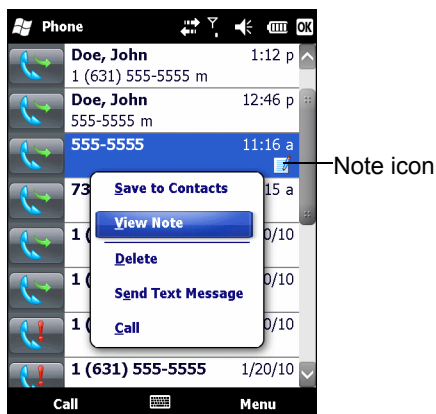



Figure 4-6 Call History - Notes Menu



4. Tap **View Note**.
5. Tap **OK** to exit.

- ✓ **NOTE** Also access notes directly from the Notes application by tapping  > **Notes**.

Using Call History

Use Call History to call someone who was recently called, or recently called in. Call History provides the time and duration of all incoming, outgoing, and missed calls. It also provides a summary of total calls and easy access to notes taken during a call. [Table 4-1](#) lists the call history icons that appear in the **Call History** window.



Table 4-1 *Call History Icons*

Icon	Description
	This icon appears next to the contact information for all outgoing calls.
	This icon appears next to the contact information for all incoming calls.
	This icon appears next to the contact information for all missed calls.



Managing Call History

Change views, reset the call timer, and delete calls to manage the calls stored in Call History.

Changing the Call History View

1. Press  to display the Phone dialer.
2. From the Phone dialer, tap **Call History**.
3. Tap  > **Filter** to show the menu.
4. Select a view type from the menu to display only missed calls, outgoing calls, incoming calls, or calls listed alphabetically by caller name.
5. Tap **OK** to exit the **Call History** window.

Resetting the Recent Calls Counter

1. Press  to display the Phone dialer.
2. From the Phone dialer, tap **Call History**.
3. Tap .
4. Select **Call Timers...**

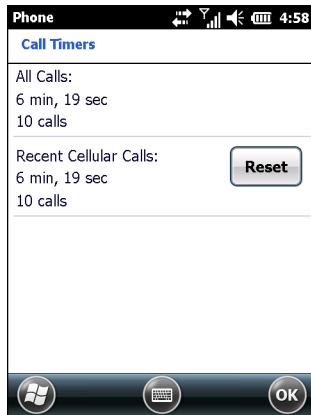



Figure 4-7 Call History - Call Timers

5. Tap **Reset**. (The **All Calls**: counter cannot be reset.)
6. Tap **OK** to exit the **Call Timers** window.

Deleting All Call History Items

1. Press  to display the Phone dialer.
2. From the Phone dialer, tap **Call History**.
3. Tap .
4. Select **Delete all calls**.
5. Tap **Yes**.
6. Tap **OK** to exit the **Call History** window.

Viewing Call Status

1. Press  to display the Phone dialer.
2. From the Phone dialer, tap **Call History**.
3. Tap an entry. The **Call Status** window appears.



Figure 4-8 Call History - Detail

✓ **NOTE** When more than one call is on the phone line, only the duration of the first call is recorded.

4. Tap **OK** and then **OK** to exit.

Using the Call History Menu

Use the **Call History** menu to dial voice mail, save to contacts, view a note, delete a listing, send an SMS and make a call.

1. Press  to display the Phone dialer.
2. From the Phone dialer, tap **Call History**.
3. Tap and hold an item in the list.

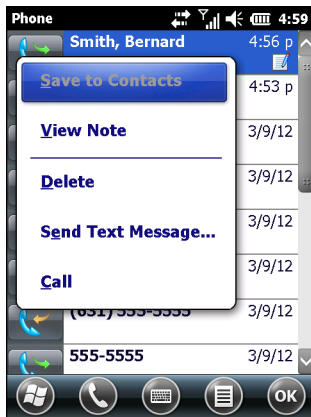

Figure 4-9 Call History - Menu

4. Select an applicable item from the menu, as needed.
5. Depending on the item selected, the appropriate window displays. For example, select **Send Text message** to display the **Text Messages** window.
6. Tap **OK** to exit the **Call History** window.

Conference Calling

✓ **NOTE** For use on GSM/UTMTS networks only.

Conference Calling and the number of conference calls allowed may not be available on all services. Please check with the service provider for Conference Calling availability.

To create a conference phone session with multiple people:

1. Press  to display the Phone dialer.
2. Enter the first phone number and press **Talk**. When the call connects, **Hold** appears on the dialer.
3. Tap **Hold** to place the first call on hold.
4. Enter the second phone number and tap **Talk**.

5. After the call is answered, tap **Conference** to place the calls in conference mode.
6. Tap **Hold** to place the conference on hold.
7. Enter another phone number and tap **Talk**.
8. After the call is answered, tap **Conference** to place all the calls in conference mode.
9. Repeat steps 6 through 8 for up to six phone numbers.
10. Tap **End** or press the red phone key on the keypad to end the conference call.

✓ **NOTE** To speak privately with one party during a conference call, tap **Private**. Select the party to make private and then tap **Private**. To include all parties again, tap **Conference**.

Making a 3-way Call

✓ **NOTE** For use with CDMA networks only.

3-way Calling may not be available on all services. Check with service provider for availability.

With 3-way Calling, the user can talk to two people at the same time. When using this feature, the normal airtime rates will be changed for each of the two calls.

1. Enter a number and press **Talk**.
2. Once you have established the connection, enter or select a number and tap **Talk**.
3. When you are connected to the second party, tap **Talk** to begin the 3-way call.

If one of the people you called hangs up during the call, the two remaining callers stay connected. If you initiated the call and are the first to hang up, all callers are disconnected.

Swapping Calls (GSM/UMTS)

✓ **NOTE** For use with GSM/UMTS networks only.

To move between two phone calls:

1. Press  to display the Phone keypad.
2. Enter the first phone number and press **Talk**. When the call connects, **Hold** appears on the keypad.

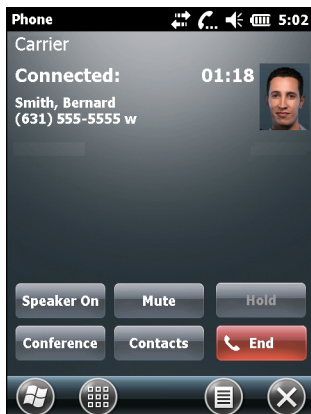

Figure 4-10 *Call Swapping - Hold*

3. Tap **Hold** on to place the first number on hold.
4. Enter the second number and tap **Talk**.

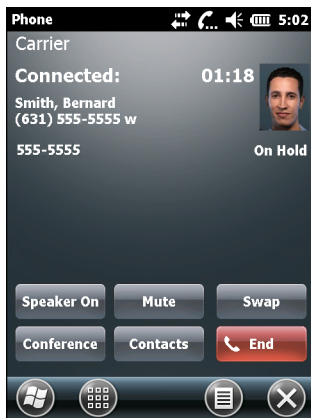

Figure 4-11 *Call Conferencing - Conferencing*

5. Tap **Swap** to move from one call to the other.
6. Tap **End** or press the red phone key on the MC67 keypad to end each call.

Swapping Calls (CDMA)

✓ **NOTE** For use with CDMA networks only.

To swap between two incoming phone calls:

1. Tap **Answer** (icon) to connect to the first call.

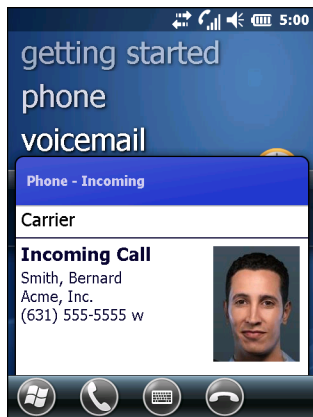

Figure 4-12 Answer a Call

2. When a second call arrives, tap **Answer (icon)**. The first call is placed on hold.
3. Tap **Talk** to swap from one call to the other.

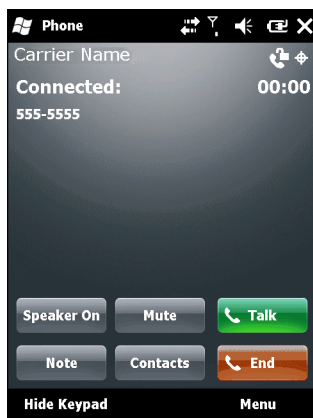

Figure 4-13 Call Swapping

4. Tap **End** or press the red phone key on the keypad to end the active call. The remaining call re-connects.
5. Tap **End** or press the red phone key on the keypad to end the last call.

Speed Dial Setup

Create speed dial numbers to dial frequently called numbers with a single tap. Before creating a speed dial entry, ensure the phone number exists in **Contacts**.

Adding a Speed Dial Entry

To add a speed dial entry from the phone keypad:

1. Ensure the contact and phone number are in the Contacts list.
2. Press .
3. Tap **Speed Dial** button > **Menu** > **New**.

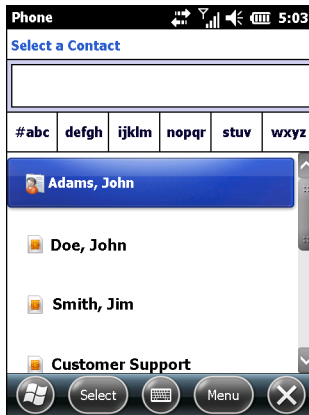

Figure 4-14 *Contacts*

4. Tap the desired contact name and number in the list.

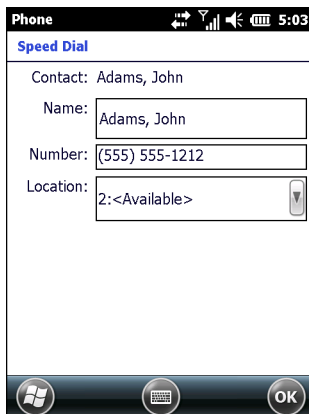

Figure 4-15 *Speed Dial Contact Location*

5. In the **Location** field, tap the up/down arrows to select an available location to assign as the new speed dial entry. The first speed dial location is reserved for voice mail.
6. Tap **OK** to add the contact to the speed dial list.

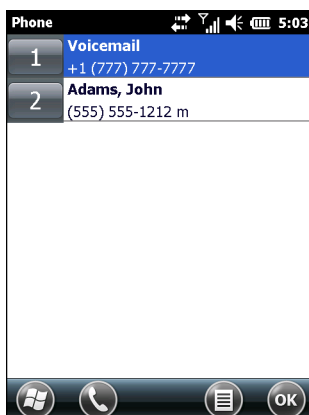

Figure 4-16 *Speed Dial Contact List*

7. Tap **OK** to exit the **Speed Dial Contact List**.

To add a speed dial entry from the **Contacts** window:

1. Tap  > **Contacts**.

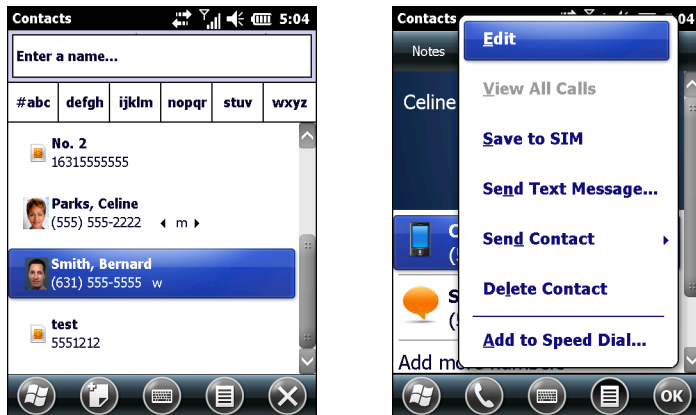

Figure 4-17 *Contacts*

2. Tap a contact name.
3. Tap **Menu** > **Add to Speed Dial**.

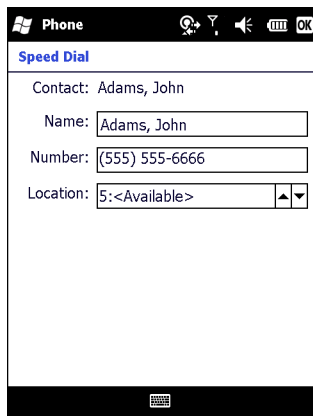

Figure 4-18 *Speed Dial Contact Location*

4. Tap the up/down arrows to select an available location to assign as the new speed dial entry. The first speed dial location is reserved for voice mail.
5. Tap **OK**.

Editing a Speed Dial Entry

To change a speed dial entry:

1. Press .
2. Tap **Speed Dial** button.

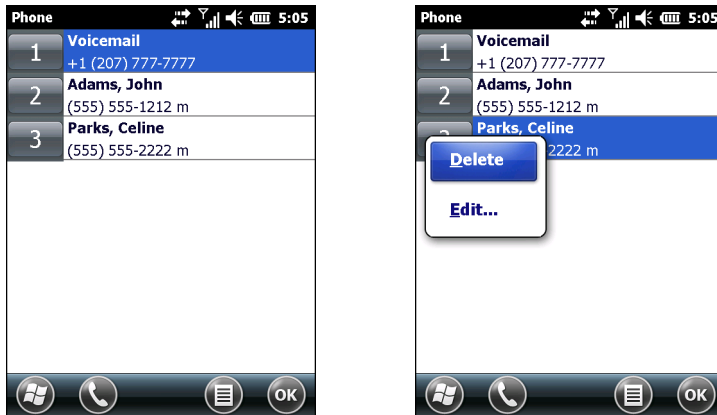



Figure 4-19 Speed Dial Contact List

3. Tap and hold the contact name.
4. Tap **Edit...**
5. Change the name, phone number, or location information.
6. Tap **OK**.

✓ **NOTE** Editing names and phone numbers in **Speed Dial** does not alter contact information in **Contacts** (☰ > **Contacts**).

Deleting a Speed Dial Entry

To delete a speed dial entry:

1. Press .
2. Tap **Speed Dial** button.
3. Tap and hold the contact name.
4. Tap **Delete**.
5. Tap **Yes** to confirm permanently deleting the speed dial entry.

✓ **NOTE** Deleting names and phone numbers in *Speed Dial* does not delete the contact information in **Contacts** (☰ > **Contacts**).

CHAPTER 5 USING WLAN

Introduction

Wireless Local Area Networks (WLANs) allow the MC67 to communicate wirelessly inside a building. Before using the MC67 on a WLAN, the facility must be set up with the required hardware to run the WLAN (sometimes known as infrastructure). The infrastructure and the MC67 must both be properly configured to enable this communication.

Refer to the documentation provided with the infrastructure (access points (APs), access ports, switches, Radius servers, etc.) for instructions on how to set up the infrastructure.

Once the infrastructure is set up to enforce the chosen WLAN security scheme, use the Fusion Wireless Companion software to configure the MC67 to match.

Fusion Overview

The Fusion Wireless Companion software contains applications with which to create wireless profiles. Each profile specifies the security parameters to use for connecting to a particular WLAN as identified by its Extended Service Set Identification (ESSID). The Fusion Wireless Companion software also allows the user to control which profile out of a set of profiles is used to connect. Other Fusion Wireless Companion applications allow the user to monitor the status of the current WLAN connection and to invoke diagnostic tools for troubleshooting.

To access Fusion Wireless Companion, tap  > **Wireless Companion** > **Wireless Launch**.

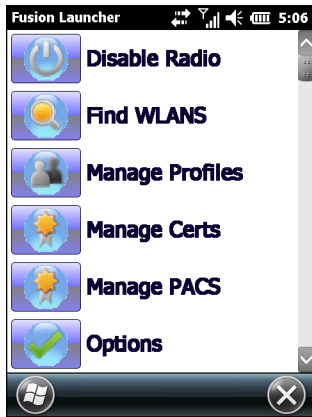



Figure 5-1 Wireless Launch Window

Refer to the *Wireless Fusion Enterprise Mobility Suite User Guide for Version X2.xx* for detailed information on using and configuring Fusion Wireless Companion.

To access the on-device Fusion Help tap  > **Wireless Companion** > **Fusion Help**.

Connecting to the Internet

To connect to the Internet on a WLAN when using Fusion Wireless Companion, ensure that the network card settings is set to Internet:

1. Ensure Fusion is enabled and a profile is configured.
2. Tap  > **Settings** > **Connections** > **Wi-Fi**.
3. In the **My network card Connects to** drop-down list, select **The Internet**.
4. Tap **OK**.

Supported Applications

The Fusion menu items and their corresponding applications are summarized in [Table 5-1](#).

Table 5-1 Supported Applications

Application	Description
Find WLANs	Invokes the Find WLANs application which displays a list of the WLANs active in the area.
Manage Profiles	Invokes the Manage Profiles application (which includes the Profile Editor Wizard) to manage and edit the list of WLAN profiles.
Manage Certs	Invokes the Certificate Manager application which allows the user to manage certificates used for authentication.
Manage PACs	Invokes the PAC Manager application which helps the user manage the list of Protected Access Credentials used with Extensible Authentication Protocol-Flexible Authentication via Secure Tunneling (EAP-FAST) authentication.

Table 5-1 Supported Applications (Continued)

Application	Description
Options	Invokes the Options application which allows the user to configure the Fusion option settings.
Wireless Status	Invokes the Wireless Status application which allows the user to view the status of the current wireless connection.
Wireless Diagnostics	Invokes the Wireless Diagnostics application which provides tools with which to diagnose problems with the wireless connection.
Log on/off	Invokes the Network Login dialog which allows the user to log on to a particular profile or to log off from the currently active profile
Fusion Help	Invokes Fusion Help application which provides on-device Help.

Fusion Setup

For detailed WLAN setup using Fusion, refer to the *Wireless Fusion Enterprise Mobility Suite User Guide for Version X2.xx*.

To setup WLAN using Fusion:

- ✓ **NOTE** Obtain the proper WLAN configuration information from the system administrator prior to performing the Fusion setup procedures.

The following setup procedure example shows setup of a WLAN using Wired Equivalent Privacy (WEP) encryption.

1. Tap the  > **Wireless Companion** > **Wireless Launch** > **Manage Profiles**. The **Manage Profiles** window appears.
2. Tap and hold in the window and select **Add** from the pop-up menu. The **Wireless LAN Profile Entry** window appears.
3. In the **Profile Name** text box enter a name for the profile.
4. In the **ESSID** text box enter the ESSID.

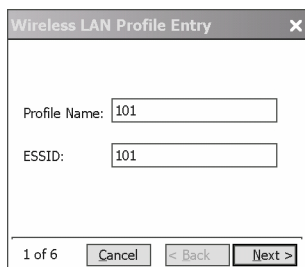

Figure 5-2 Profile ID Dialog Box

5. Tap **Next**. The **Operating Mode** dialog box displays.
6. In the **Operating Mode** drop-down list, select **Infrastructure** or **Ad-hoc**.

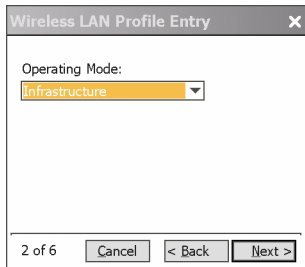

Figure 5-3 *Operating Mode Dialog Box*

7. Tap **Next**. The **Security Mode** dialog box displays.
8. In the **Security Mode** drop-down list, select **Legacy (Pre-WPA)**.

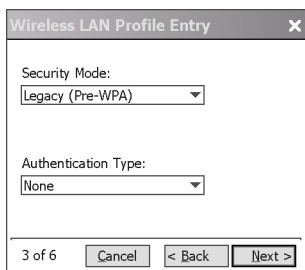

Figure 5-4 *Security/Authentication Dialog Box*

9. In the **Authentication** drop-down list, select **None**.
10. Tap **Next**. The **Encryption** dialog box displays.
11. In the **Encryption Type** drop-down list, select **WEP-40 (40/24)**.

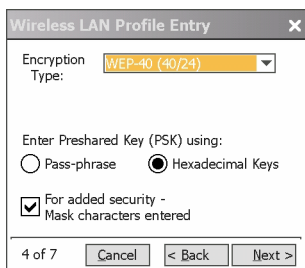

Figure 5-5 *Encryption Dialog Box*

12. Select the **Pass-phrase** or **Hexadecimal Keys** radio button to indicate whether a pass-phrase or hexadecimal keys will be entered on the next page.
13. Select the **For added security - Mask characters entered** check box to hide characters entered. Deselect this to show characters entered.
14. Tap **Next**.

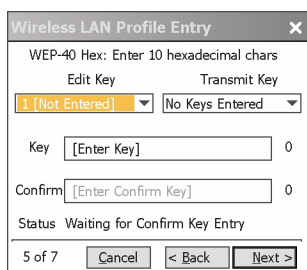

Figure 5-6 WEP-40 WEP Keys Dialog Box

15. In the **Edit Key** drop-down list, select the key to enter.
16. In the **Key** field, enter 10 hexadecimal characters.
17. In the **Confirm** field, re-enter the key. When the keys match, a message appears indicating that the keys match.
18. Repeat for each WEP key.
19. In the **Transmit Key** drop-down list, select the key to transmit.
20. Tap **Next**. The **IPv4 Address Entry** dialog box displays.

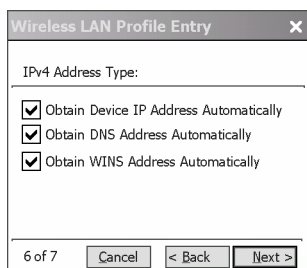

Figure 5-7 IP Address Entry Dialog Box

21. Ensure that all three check boxes are selected.
22. Tap **Next**. The **Battery Usage** dialog box appears.
23. In the **Battery Usage Mode** dialog box select a power consumption option.

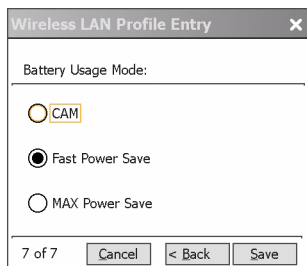

Figure 5-8 Battery Usage Dialog Box

24. Tap **Next**. The **Performance Settings** dialog box appears.
25. In the **Performance Settings** dialog box select either **Optimize for Data** or **Optimize for Voice**.
26. Tap **Save**.

CHAPTER 6 MESSAGING

Introduction

This chapter describes how to use Email and text messaging.

Email

Use email to send messages to other users. See [Email Setup on page 6-6](#) for information on setting up an Email account.

Creating an Email Message

To create an email message:

1. Press  > **E-mail**.
2. Select an email account.
3. Tap  > **New**.
4. To add recipients, enter their email addresses, separating them with a semicolon (;). Tap **To** to add email addresses stored in **Contacts**.
5. Enter a subject and compose the message.
6. To add an attachment to the message, tap  > **Insert** and tap the item to attach: **Picture**, **Voice Note**, or **File**.
7. Tap .

Viewing an Email Message



To view an email message:

1. Press  > **E-mail**.

2. Select an email account.
3. Tap an email to open it.

Replying to a Message

To reply to a message:

1. Press  > **E-mail**.
2. Select an email account.
3. Tap an email to open it.
4. Tap .
5. Enter a reply message, and then tap .

Text Messaging

Use the **Text Messages** window to send and receive text messages to and from mobile phones. The text can contain words, numbers, or an alphanumeric combination no longer than 160 characters.

Short text messages delivered over mobile networks transmit from the sending MC67, are stored in a central short message center, then forwarded to the destination mobile device. If the recipient is not available, the message is stored and can be sent later.

Viewing Text Messages

The user can view a text message whether the phone is on or off. When the phone is on, the user can view a text message from its notification pop-up. Tap the **text message notification** icon on the navigation bar to display the message.

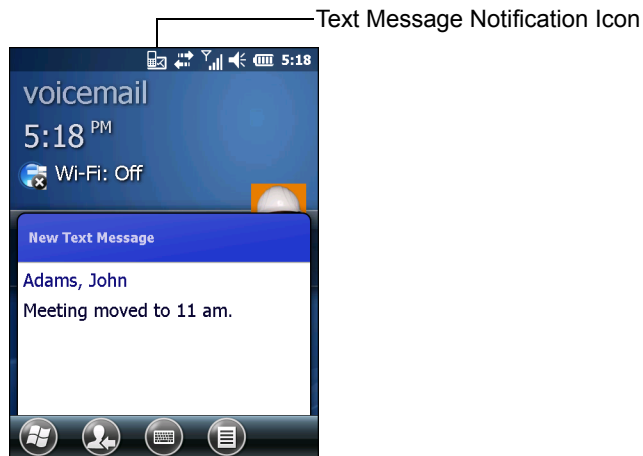

Figure 6-1 *New Text Message Notification*

The Caller Identification feature matches incoming text message numbers with those stored in **Contacts** so the user knows who is sending the message. Furthermore, the **New Text Message** dialog box gives the user the option to call the sender or save, dismiss, or delete the message.



Figure 6-2 New Text Message Options

When the phone function is off, the user can still view received text message:

1. Tap > **Text** or on the Today screen, tap the text message on the Information Bar.



Tap to View Text Messages.

Figure 6-3 Text Messaging on Today Screen

2. The **Text Messages** window appears.
3. In the message list, tap the text message.

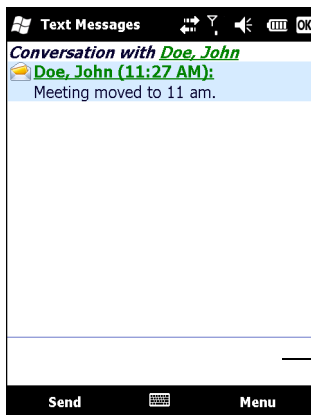

Enter reply here.

Figure 6-4 Text Messages List



NOTE If the phone is turned off and the user tried to call the sender, send a reply, or forward the message, the user is prompted to turn the phone function on.

Sending a Text Message

To create a text message:

1. On the **Phone** screen, select a contact name to send a message to.
2. Tap **Menu > Send Text Message**.

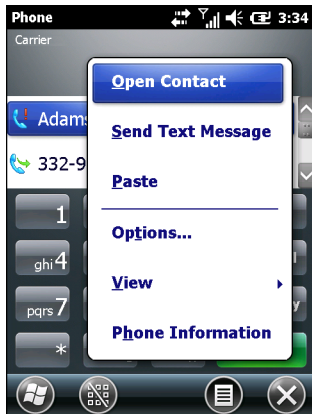

Figure 6-5 Phone Screen Contact List

3. Compose the message.

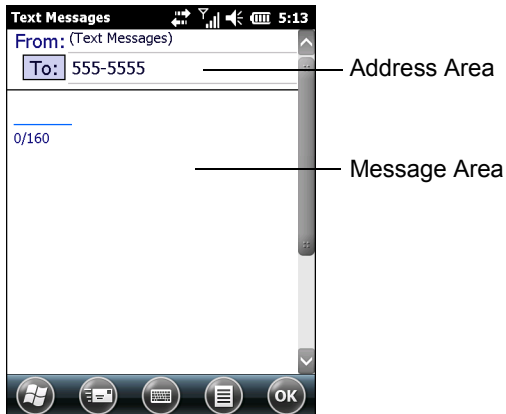

Figure 6-6 Create Text Message

- The auto-correct feature automatically fixes common spelling errors as the user types so the messages are more accurate.
 - The character counter lets the user see and control the size of the message.
 - If the user wants to know if the text message was received, tap **Menu > Message Options**, then select the **Request message delivery notification** check box.
4. Tap **Send** when finished the message.
- If the phone is turned on, the text message is sent. If it is off, the user is prompted to turn on the phone. If the user does so, the message is sent; otherwise tap **OK**, the message is saved in the **Drafts** folder and sent when the phone is turned on.

If the user is out of coverage area, the message is saved in the **Drafts** folder. The user has to manually re-send it when the user returns to a coverage area.



Using a Dual Line SIM

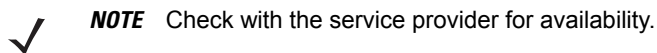

Dual line SIM cards allow for two phone lines on a single card. For example, one line can be a business phone line and the other a personal phone line.

To switch between phone lines:

1. Tap  > **Programs** > **SIM Toolkit**.

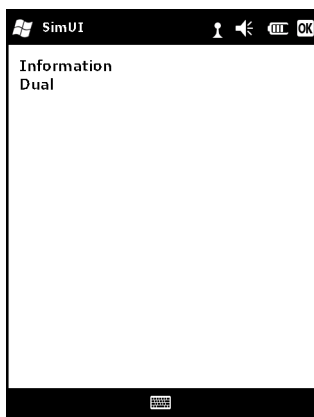

Figure 6-7 SIM UI Window

2. Select **Dual** and then tap **Select**.

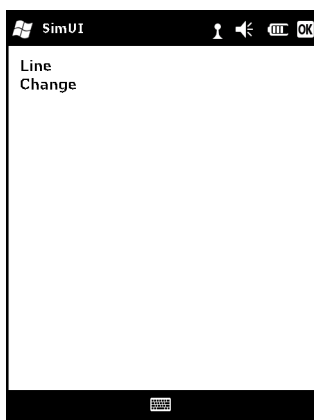

Figure 6-8 Change Phone Line

3. Select **Change** and then tap **Select**.
4. If applicable, sign in with the PIN number for the other line.

Email Setup

The MC67's **Messaging** application lets users access and manage multiple email accounts simultaneously in one convenient location. To send and receive email messages through an ISP (Internet Service Provider) account, or to use the MC67 to access corporate email through a VPN (Virtual Private Network), first set up an IMAP or POP account.

- IMAP (Internet Message Access Protocol) - This mail retrieval protocol is frequently used in large networks and commercial and institutional settings. IMAP4 is the current standard.
- POP (Post Office Protocol) - This protocol is supported by most ISPs and is currently more common among consumer applications. POP3 is the current standard.

✓ **NOTE** If the user has multiple email accounts, configure each account with its own settings.

Setting Up an IMAP or POP Account

When setting up an IMAP or POP account, the MC67 may be able to retrieve account settings automatically, or the user may need to enter certain settings manually.

Automatic Email Setup

1. Tap  > **E-mail**.
2. Tap **Setup E-mail**.
3. In the **E-mail address** text box, enter an email address.
4. In the **Password** text box, enter an associated password.
5. The **Save password** checkbox is checked by default to allow the MC67 to always remember the email account password. To prevent other users from viewing the email account, tap the **Save password** checkbox to remove the checkmark and deactivate the feature.
6. Tap **Next**.

✓ **NOTE** For some common email types, the MC67 automatically detects and configures the email settings without performing this step.

7. Tap the **Try to get e-mail settings automatically from the Internet** checkbox to place a checkmark in the checkbox.

Tap **Next** to attempt to retrieve these settings automatically. This process may take several minutes. The MC67 attempts to determine the necessary communication settings for both incoming and outgoing email messages.

8. If the MC67 was able to automatically retrieve the necessary settings, tap **Next**.
If the MC67 was unable to obtain the settings automatically, tap **Next** and proceed to step 8 in [Entering Email Settings Manually on page 6-7](#).
9. In the **Your name:** field, enter the name that displays in the **From** field on outgoing messages.
10. In the **Account display name:** field enter a name for the new email account.
This name appears within the list of available email accounts on the E-mail page.

11. Tap **Next**.
12. Tap the **Automatic Send/Receive**: field and select the time interval for the MC67 to send and check for new email messages.
13. Tap the **Review all download** settings link for additional download settings and options. See [Editing an Email Account on page 6-8](#) for more details.
14. Tap **Finish**.

Manual Email Setup

If the Automatic configuration was unsuccessful, or if accessing an account using a VPN server connection, contact the Internet Service Provider (ISP) or network administrator for the following information and enter it manually:

- Account type (IMAP4 or POP3)
- Incoming and outgoing mail server names
- Username and password
- Domain name
- Special security settings (if used).

For more information about configuring email accounts, go to: www.microsoft.com.

Entering Email Settings Manually

1. Tap  > **E-mail**.
2. Tap **Setup E-mail**.
3. In the **E-mail address**: field, enter the email address for the account.
4. In the **Password**: fields and the password for the account.
5. The **Save password** checkbox is checked by default to allow the MC67 to always remember the email account password. To prevent other users from viewing email, tap the **Save password** checkbox to remove the checkmark and deactivate the feature.
6. Tap **Next**.
7. Tap the **Try to get e-mail settings automatically** from the Internet box to remove the checkmark from the box and tap **Next**.
8. In the **Your e-mail provider**: drop-down list, select **Internet e-mail** and tap **Next**.
9. In the **Your name**: field enter the name that will display in the **From** field on outgoing messages.
10. In the **Account display name**: field enter a name for this new email account.
This name appears within the list of available email accounts on the E-mail page.
11. Tap **Next**.
12. In the **Incoming mail server**: field enter the incoming mail server address.
13. In the **Account Type**: drop-down list, select either **POP3** or **IMAP4**.
14. Tap **Next**.

15. In the **User name:** field enter the username for the account.
16. In the **Password:** field enter the password for the account.
17. Tap **Next**.
18. In the **Outgoing (SMTP) mail server:** field enter the outgoing mail server address.
19. Check the appropriate fields and then tap **OK**.
 - **Outgoing server requires authentication** is used if a password is required for outgoing mail in addition to incoming mail. (Please contact the System Administrator for detailed server requirements.)
Use the same user name and password for sending e-mail to use the same user name and password for outgoing mail as well as for incoming mail (can only be selected if the **Outgoing server requires authentication** checkbox is checked).
20. Tap the **Advanced Server Settings** link.
 - These allows configuration of server-specific messaging settings such as SSL requirements for both incoming and outgoing email, as well as network firewall profiles.
 - Select the desired options.
 - Tap **Done** once completed making updates to these settings.
21. Tap **Next**.
22. In the **Automatic Send/Receive:** drop-down list select the time interval for the MC67 to send and check for new email.
23. Tap the **Review all download settings** link for additional download settings and options.
24. Tap **Finish**.

Editing an Email Account

To edit general email settings:

1. Tap  > **E-mail**.
2. Highlight an account and tap **Menu > Options**.
3. Tap the desired email account from the on screen list.
4. Tap **Edit Account Setup**.
5. Confirm the **email address** and make any changes if necessary. Tap **Next**.
6. Confirm the **Your name** and **Account display name** information and make any changes if necessary. Tap **Next**.
7. Confirm the **Incoming mail server** and **Account type** information and make any changes if necessary. Tap **Next**.
8. Confirm the **User name** and **Password** information and make any changes if necessary (including checking or unchecking the **Save password** checkbox). Tap **Next**.
9. Confirm the **Outgoing (SMTP) mail server** information and make any changes if necessary.
10. Tap the **Advanced Server Settings** link and select any setting on this page to check or uncheck the option.

- **Require SSL for Incoming e-mail** check box to enable SSL encryption of incoming email (if supported by the mail server).
 - **Require SSL for Outgoing e-mail** checkbox to enable SSL encryption of outgoing email (if supported by the mail server).
 - **Network connection** drop-down list to select a firewall connection setting. Select either **The Internet** (open: no firewall), **Work** (behind a firewall) or a data connection.
11. Tap **Done** and then tap **Next**.
 12. In the **Automatic Send/Receive** drop-down list, select the time interval the MC67 sends and checks for new email.
 13. In the **Download messages** drop-down list, select the age range of messages to download from the server to the MC67. (The longer the time period, the more messages are downloaded.)
 14. Tap the **Advanced Settings** link and select any setting on this page to check or uncheck the option.
 - Select the **Send/receive when I click Send** checkbox to automatically check for and download new messages whenever the user sends a message.
 - Select the **Use automatic send/receive schedule when roaming** checkbox to continue to check the email at predetermined intervals even if in a roaming area.
 - In the **When deleting messages** drop-down list select whether to automatically delete or retain messages on the email server when deleting messages from the MC67.
 15. Tap **Done**.
 16. Tap **Next**.
 17. Tap an on-screen field and change any settings. Tap an option to select it.
 - In the **Message format** drop-down list, select to view the email messages as either **HTML** or **plain text** documents.
 - In the **Message download limit** drop-down list, select the size limit of files attached to email messages.
 18. Tap **Finish**.

Setting Email Signatures

Signatures are the string of text automatically added to the end of an outgoing emails or messages.

1. Tap  > **E-mail**.
2. Tap **Menu** > **Options**.
3. Highlight an account and tap **Signatures**.
4. In the **Select an account** drop-down list, select a pre-existing account.
5. Tap the **Use signature with this account** checkbox to enable a signature to be automatically added to new outgoing messages.
6. Tap the **Use when replying and forwarding** checkbox to enable a signature to be automatically added to any messaging being replied to or being forwarded from the account.
7. Tap in the text field and enter a signature message.
8. Tap **OK** to save the new signature.

CHAPTER 7 BLUETOOTH

Introduction

Bluetooth-equipped devices can communicate without wires, using frequency-hopping spread spectrum (FHSS) radio frequency (RF) to transmit and receive data in the 2.4 GHz Industry Scientific and Medical (ISM) band (802.15.1). Bluetooth wireless technology is specifically designed for short-range (10 meters/32 feet) communication and low power consumption.

MC67s with Bluetooth capabilities can exchange information (e.g., files, appointments, and tasks) with other Bluetooth enabled devices such as phones, printers, access points, and other mobile computers. To use the MC67 as a modem, create a dial-up modem connection between a computer and MC67.

The MC67 with Bluetooth technology uses either the StoneStreet Bluetooth stack or the Microsoft Bluetooth stack. To write an application that uses the StoneStreet One Bluetooth stack APIs, refer to the Enterprise Mobility Developer Kit (EMDK) Help.

Adaptive Frequency Hopping

Adaptive Frequency Hopping (AFH) is a method of avoiding fixed frequency interferers, and can be used with Bluetooth voice. All devices in the piconet (Bluetooth network) must be AFH-capable in order for AFH to work. There is no AFH when connecting and discovering devices. Avoid making Bluetooth connections and discoveries during critical 802.11b communications. AFH for Bluetooth consists of four main sections:

- Channel Classification - A method of detecting an interference on a channel-by-channel basis, or pre-defined channel mask.
- Link Management - Coordinates and distributes the AFH information to the rest of the Bluetooth network.
- Hop Sequence Modification - Avoids interference by selectively reducing the number of hopping channels.
- Channel Maintenance - A method for periodically re-evaluating the channels.

When AFH is enabled, the Bluetooth radio “hops around” (instead of through) the 802.11b high-rate channels. AFH coexistence allows Zebra mobile computers to operate in any infrastructure.

The Bluetooth radio in this MC67 operates as a Class 2 device power class. The maximum output power is 2.5mW and the expected range is 10 meters (32 feet). A definition of ranges based on power class is difficult to obtain due to power and device differences, and whether one measures open space or closed office space.



NOTE It is not recommended to perform Bluetooth wireless technology inquiry when high rate 802.11b operation is required.

Security

The current Bluetooth specification defines security at the link level. Application-level security is not specified. This allows application developers to define security mechanisms tailored to their specific need. Link-level security occurs between devices, not users, while application-level security can be implemented on a per-user basis. The Bluetooth specification defines security algorithms and procedures needed to authenticate devices, and if needed, encrypt the data flowing on the link between the devices. Device authentication is a mandatory feature of Bluetooth while link encryption is optional.

Pairing of Bluetooth devices is accomplished by creating an initialization key that is used to authenticate the devices and create a link key for them. Entering a common Personnel Identification Number (PIN) number in the devices being paired generates the initialization key. The PIN number is never sent over the air. By default, the Bluetooth stack responds with no key when a key is requested (it is up to user to respond to the key request event). Authentication of Bluetooth devices is based-upon a challenge-response transaction. Bluetooth allows for a PIN number or passkey that is used to create other 128-bit keys used for security and encryption. The encryption key is derived from the link key used to authenticate the pairing devices. Also worthy of note is the limited range and fast frequency hopping of the Bluetooth radios that makes long-distance eavesdropping difficult.

Recommendations are:

- Perform pairing in a secure environment
- Keep PIN codes private and don't store the PIN codes in the mobile computer
- Implement application-level security.

The Microsoft stack supports Smart-pairing. For detailed information, refer to the Microsoft MSDN.

Security Mode 3 (Link Level Encryption)

The MC67 supports Security Level 3 (Link Level Encryption). Link level encryption is the data security process of encrypting information at the data link level as it is transmitted between two devices.

Microsoft Bluetooth Stack

When pairing with a remote device using the Microsoft Bluetooth UI, Security Level 3 (Link Level Encryption) is automatically used. When developing applications using the Microsoft Bluetooth stack, enable Security Mode 3 using the *BthSetEncryption* API call. Refer to the Microsoft MSDN for more information.

StoneStreet One Bluetooth Stack

To set Security Mode 3 on outgoing serial port connections, set **Encrypt Link On All Outgoing Connections** checkbox in the **Settings > Security**. See [Security on page 7-39](#) for more information.

FIPS 140-2

The MC67 supports FIPS 140-2 for Bluetooth using the Microsoft Bluetooth stack and the StoneStreet One Bluetooth stack. FIPS provides secure Bluetooth communication between the MC67 and another mobile computer or scanner only using a Serial Port Profile.

Bluetooth Configuration

By default, the MC67 is configured to using the Microsoft Bluetooth stack. Refer to the *MC67 Integrator Guide, Appendix B*, for information on switching to the StoneStreet One Bluetooth stack.

[Table 7-1](#) list the services supported by the Microsoft Bluetooth stack and the StoneStreet One Bluetooth stack.

Table 7-1 *Bluetooth Services*

Service	Microsoft Bluetooth	StoneStreet One Bluetooth
Generic Access Profile (GAP)	Yes	Yes
Service Discovery Protocol (SDP) Profile	Yes	Yes
Serial Port Profile (Server and Client)	Yes	Yes
Hands-free Profile (Audio Gateway)	Yes	Yes
Headset Profile (Audio Gateway)	Yes	Yes
Dial-Up Networking (DUN) Profile (Gateway Role)	Yes	Yes
Generic OBEX Push Profile	Yes	No
File Transfer Protocol (Client Role)	No	Yes
Synchronization Profile	No	Yes
Personal Area Networking Profile (PANU/GN)	No	Yes
Advanced Audio Distribution Profile (A2DP)	Yes	Yes
Audio/Video Remote Control Profile (AVRCP)	Yes	Yes
Phonebook Access Profile	Yes	Yes
Human Interface Device (HID) Profile	Yes	Yes

[Table 7-2](#) list the COM ports available for the StoneStreet One Bluetooth stack and the Microsoft Bluetooth stack.

Table 7-2 COM Ports

Microsoft Bluetooth Stack	StoneStreet One Bluetooth Stack
COM5	COM5
COM9	COM9
FIP2	COM11
	COM21
	COM22
	COM23
	FIP2

Bluetooth Power States

Cold Boot

Performing a cold boot retain the state of the Bluetooth radio prior to the cold boot.

Warm Boot

Performing a warm boot retain the state of the Bluetooth radio prior to the warm boot.

Suspend

When there is an active Bluetooth connection, the Bluetooth radio goes into low power mode maintaining the active connection. When there is no active connection, the Bluetooth radio turns off.

With StoneStreet One Bluetooth Stack

- ✓ **NOTE** If there is an active Bluetooth connection between the MC67 and another Bluetooth device, the MC67 will not timeout. However, if the user presses the Power button on the MC67, the MC67 will suspend and upon receiving data from a remote Bluetooth device, the MC67 will wake from suspend mode. For example, Bluetooth scanner sending data to the MC67.

With Microsoft Bluetooth Stack

- ✓ **NOTE** If there is an active Bluetooth connection between the MC67 and another Bluetooth device and there is no data activity, the MC67 will timeout. However, if the user presses the Power button on the MC67, the MC67 will suspend and upon receiving data from a remote Bluetooth device, the MC67 will wake from suspend mode. For example, Bluetooth scanner sending data to the MC67.

Resume

When the MC67 resumes, Bluetooth turns on if it was on prior to suspend.

MotoBTUI Application

Use the MotoBTUI application to:

- Turn the Bluetooth radio on and off. See [Turning the Bluetooth Radio Mode On and Off on page 7-6](#).
- View device information
- Control device status
- Generate a pairing bar code (See [Using the RS507 Hands-free Imager on page 10-19](#) for more information).
- Configure FIPS key.

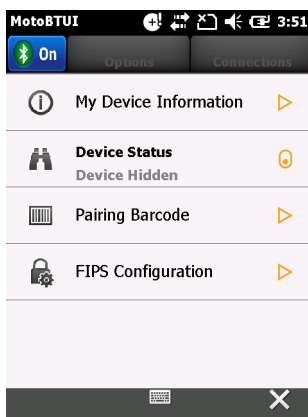

Figure 7-1 MotoBTUI Window

Device Information

The view the MC67 Bluetooth information:

1. Tap **Start > MotoUI**.
2. Tap **My Device Information**.
3. The **Device Information** window displays:
 - Device Name
 - HCI version number
 - LMP version number
 - Bluetooth chip manufacturer name
 - BT UI version number.
4. Tap the Back button to return to the **MotoBTUI** window.

FIPS Configuration

- ✓ **NOTE** By default the MC67 has a FIPS key installed. If required, the user can generate a new FIPS key. If a new key is generated on the MC67, the same key is required to be used on the other Bluetooth device. The user must transfer the key to the other device.

To generate a new FIPS key automatically:

1. Tap **Start > MotoUI**.
2. Tap **FIPS Configuration**.
3. Tap **Generate Key** button.
4. Tap the **SetUp Key** button. A new key is generated. The key file, NewAESKey.reg, is created in the */Application* folder.
5. Tap the Back button to return to the **MotoBTUI** window.

To generate a new FIPS key manually:

1. Tap **Start > MotoUI**.
2. Tap **FIPS Configuration**.
3. Tap **Enter Key** button.
4. In the text box, enter a key.
5. Tap the **SetUp Key** button. A new key is generated. The key file, NewAESKey.reg, is created in the */Application* folder.
6. Tap the Back button to return to the **MotoBTUI** window.

To transfer the new FIPS key to another Bluetooth device:

1. Copy the NewAESKey.reg file from the MC67 to the other Bluetooth device. Place the file into the */Application* folder.
2. Navigate to the */Application* folder.
3. Locate the NewAESKey.reg file and tap the filename. The **RegMerge** confirmation box displays.
4. Tap **Yes**.
5. Perform a warm boot.

Device Status

Use the Device Status option to set if the MC67 would be seen by other Bluetooth devices. Touch the **Device Status** option to toggle the MC67 from Hidden to Discoverable.

Using Microsoft Bluetooth Stack

The following sections provide information on using the Microsoft Bluetooth stack.

Turning the Bluetooth Radio Mode On and Off



NOTE Turn the Bluetooth radio on or off using the **Wireless Manager**. Tap the Status bar and select the **Connectivity** icon. Tap **Wireless Manager**.

Turn off the Bluetooth radio to save power or if entering an area with radio restrictions (e.g., an airplane). When the radio is off, other Bluetooth devices cannot see or connect to the MC67. Turn on the Bluetooth radio to

exchange information with other Bluetooth devices (within range). Communicate only with Bluetooth radios in close proximity.

✓ **NOTE** To achieve the best battery life turn off radios not in use.

Enabling Bluetooth

There are three ways to enable Bluetooth:

1. Microsoft Bluetooth application:

a. Tap  > **Setting** > **Connections** > **Bluetooth** > **Mode**.

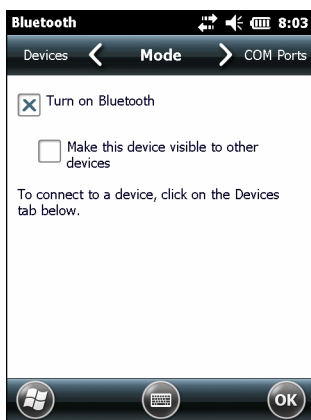

Figure 7-2 Bluetooth Mode

b. Check the **Turn On Bluetooth** checkbox to turn on the Bluetooth radio on.

c. Tap **OK**.

2. Wireless Manager:

a. Tap the Status Bar.

b. Tap the Connectivity icon.

c. Tap **Wireless Manager**.

d. Tap **Bluetooth** to turn the Bluetooth radio on.

e. Tap **X**.

3. MotoBTUI application:

a. Tap  > **MotoBTUI**.

b. Tap the Bluetooth **Off** tab to turn the Bluetooth radio on.

c. Tap **X**.

Disabling Bluetooth

There are three ways to disable Bluetooth:

1. Microsoft Bluetooth application:

a. Tap  > **Setting** > **Connections** > **Bluetooth** > **Mode**.

- b. Un-check the **Turn On Bluetooth** checkbox to turn the Bluetooth radio off.
 - c. Tap **OK**.
2. Wireless Manager:
 - a. Tap the Status Bar.
 - b. Tap the Connectivity icon.
 - c. Tap **Wireless Manager**.
 - d. Tap **Bluetooth** to turn the Bluetooth radio off.
 - e. Tap **X**.
3. MotoBTUI application:
 - a. Tap  > **MotoBTUI**.
 - b. Tap the Bluetooth **On** tab to turn the Bluetooth radio off.
 - c. Tap **X**.

Discovering Bluetooth Device(s)

The MC67 can receive information from discovered devices without pairing. However, once paired, the MC67 and a paired device exchange information automatically when the Bluetooth radio is turned on. See [Pairing with Discovered Device\(s\) on page 7-32](#) for more information.

To find Bluetooth devices in the area:

1. Ensure that Bluetooth is enabled on both devices.
2. Ensure that the Bluetooth device to discover is in discoverable and connectable modes.
3. Ensure that the two devices are within 10 meters (32 feet) of one another.
4. Tap  > **Settings** > **Connections** > **Bluetooth** > **Devices**.

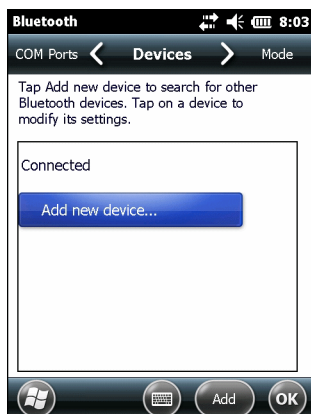

Figure 7-3 *Bluetooth - Devices*

5. Tap **Add new device**. The MC67 begins searching for discoverable Bluetooth devices in the area.

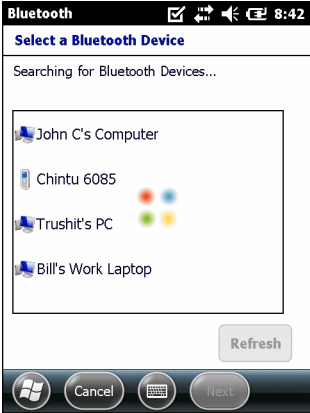

Figure 7-4 Searching for Bluetooth Devices

6. Select a device from the list.



Figure 7-5 Select a Bluetooth Device

7. Tap Next. The Enter Passcode window appears.

✓ **NOTE** If Smart-pairing is configured and the device is requesting one of the pre-defined PINs, the **Enter Passcode** window does not appear.

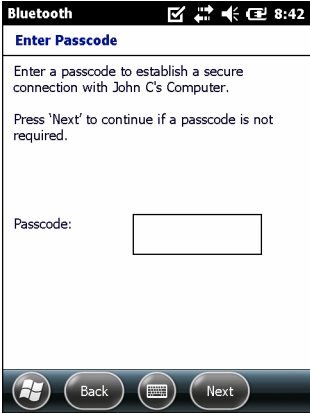

Figure 7-6 Enter Passcode

8. Enter a Passcode.

If the device has a specific passcode, enter it in the **Passcode** field and tap **Next**. If the device does not have a specific passcode, enter one in the **Passcode** field and tap **Next**. The MC67 tries to connect with the other device.

9. If you created a passcode, you will be prompted by the other device to enter the same passcode. Enter the created passcode to establish a paired connection. (If you entered a passcode from the device, you should not have to do anything on the other device).

10. When the connection is complete, a list of matching and supported services on the device appears.

11. Select the services to use and tap **Finish**. The services on the new devices have to be selected or else the pairing won't include those services, even though the devices are paired. If services are not selected, you will be continually reprompted for the passcode from the device.

12. The device appears in the list on the main window.

After the passcodes have been accepted on both sides, a trusted ("paired") connection is created.

Available Services

✓ **NOTE** Some devices might not require a PIN. This depends upon the device's authentication.

The MC67 with Microsoft Bluetooth stack offers the following services:

- OBEX Object Push Services via Beam
- Serial Port Services
- Personal Area Networking Services
- PBAP Services
- Dial-up Networking Services
- A2DP/AVRCP Services.

See the following sections for information on these services.

Object Push Services via Beam

✓ **NOTE** The MC67 only send files to a remote device using the Beam function.

Use the OBEX Push Service to send files and contacts to another Bluetooth device. To transfer files between the MC67 and another Bluetooth enabled device:

1. Ensure that Bluetooth is enabled and discoverable on both devices.
2. Ensure that the two devices are within 10 meters (32 feet) of one another.
3. Tap  > **Programs** > **File Explorer**.
4. Navigate to the file to transfer.
5. Tap and hold on the filename until the pop-up menu appears.

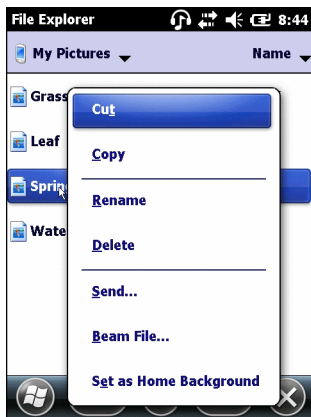

Figure 7-7 File Explorer Window

6. Select **Beam File**. The MC67 searches for Bluetooth devices in the area.
7. Tap **Tap to send** next to the Bluetooth device to send the file to. The MC67 communicates with the device and sends the file. When completed, **Tap to send** changes to **Done**.

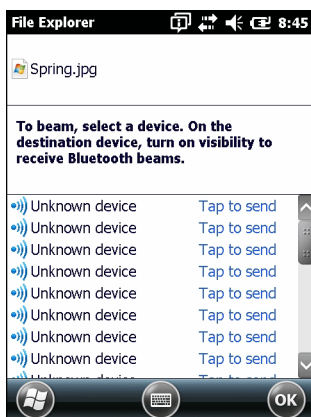

Figure 7-8 Beam File Window

To transfer a contact between the MC67 and another Bluetooth enabled device:

1. Ensure that Bluetooth is enabled and discoverable on both devices.
2. Ensure that the two devices are within 10 meters (32 feet) of one another.
3. Tap  > **Contacts**.
4. Navigate to the contact to transfer.
5. Tap and hold on the contact until the pop-up menu appears.



Figure 7-9 Contact Window

6. Select **Send Contact** > **Beam**. The MC67 searches for Bluetooth devices in the area.
7. Tap **Tap to send** next to the Bluetooth device to send the file to. The MC67 communicates with the device and send the contact. When completed, **Tap to send** changes to **Done**.

Internet Sharing

Internet Sharing allows the user to connect a computer or laptop to the MC67 and use the MC67 as a modem to connect to an office network or Internet Service Provider (ISP).

To use MC67 as a modem using Bluetooth:

1. Ensure that the MC67 is not connected to the computer or laptop.
2. On the MC67, ensure that the Phone is on and a data connection is configured.
3. Tap  > **Programs** > **Internet Sharing**.
4. In the **PC Connection** list, select **Bluetooth PAN**.
5. In the **Network Connection** list, select the connection type.
Select the network connection that the device should use to connect to the Internet.
6. Tap **Connect**.
7. On the computer or laptop, setup a Bluetooth PAN with the device.
 - a. Select **Start** > **Control Panel** > **Network Connections**.
 - b. Under **Personal Area Network**, select **Bluetooth Network Connection**.
 - c. Right-click on **Bluetooth Network Connection** and select **View Bluetooth** network devices.
 - d. In the **Bluetooth Personal Area Network Devices** window select the MC67.
 - e. Click **Connect**. The computer connects to the MC67 via Bluetooth.



NOTE If the computer is Bluetooth-enabled and Bluetooth as the PC connection is selected, the user must initiate and complete the Bluetooth PAN partnership before Internet Sharing will work. For more information, refer to Windows Help and Support.

8. To verify, on the computer or laptop, launch **Internet Explorer** and open a web site.
9. To end internet sharing, on the MC67 tap **Disconnect**.

Serial Port Services

Use the wireless Bluetooth serial port connection as a physical serial cable connection. Configure the application that will use the connection to the correct serial port.

To establish a serial port connection:

1. Ensure that Bluetooth is enabled and discoverable on both devices.
2. Ensure that the two devices are within 30 feet (10 meters) of one another.
3. Tap  > **Settings** > **Connections** > **Bluetooth** > **Devices**.
4. Tap **Add new device**. The MC67 begins searching for discoverable Bluetooth devices in the area.
5. Select a device from the list.
6. Tap **Next**. The **Enter Passcode** window appears.

✓ **NOTE** If Smart-pairing is configured and the device is requesting one of the pre-defined PINs, the **Enter Passcode** window does not appear.

7. Enter the Passcode and the tap **Next**. The device is added to the Bluetooth list.
8. In the device list, tap the serial device. The **Partnership Settings** window displays.
9. Select the **Serial Port** checkbox.
10. Tap **Save**.
11. Tap **COM Ports**.
12. Tap **New Outgoing Port**. The add device window appears.

✓ **NOTE** By default, **Secure Connection** checkbox is set enabling Security Level 3 (Linked Level Encryption).

13. Select the serial device in the list and then tap **Next**.
14. Select a COM port from the drop-down list.
15. Tap **Finish**.

✓ **NOTE** No connection is made at this point. An application must open the selected COM port to trigger Microsoft Bluetooth stack to open the connection.

ActiveSync Using Serial Port Services

Use the wireless Bluetooth serial port connection for ActiveSync just as a physical serial cable connection. Configure the application that will use the connection to the correct serial port.

To set up a Bluetooth ActiveSync connection:

Before setting up a Bluetooth ActiveSync connection, configure the Bluetooth function on the host computer.

- ✓ **NOTE** For additional security, disable network bridging on the computer (specifically, bridging to a Remote NDIS adapter) before connecting to the computer to pass through to the Internet or a network. For more information on network bridging, see **Windows Help** on the computer.

Refer to the Windows Help for instructions on setting up a Bluetooth connection.

1. Ensure that Bluetooth is enabled and discoverable on both devices.
2. Ensure that the two devices are within 30 feet (10 meters) of one another.
3. Click **Start > All Programs > Microsoft ActiveSync**.
4. Click **File > Connection Settings**.



Figure 7-10 ActiveSync Connection Settings

5. On the **Allow connections to one of the following** drop-down list, select the COM port with the number noted earlier.
6. On the MC67, tap  > **Programs > ActiveSync**.
7. Tap **Menu > Connect via Bluetooth**.

Synchronization is automatically initiated.

If an Authentication is required, the **Enter Passcode** screen appears, type an alphanumeric passkey (PIN code), then tap **Next**; enter the same passkey on the other device.

The passkey is recommended for enhanced security. The passkey must be between 1 to 16 alphanumeric characters.

If the user does not want to use a passkey, tap **Next**.

8. To disconnect the ActiveSync connection, tap  > **ActiveSync > Menu > Disconnect**.
9. Tap **Disconnect**.

Phone Book Access Profile Services

Phone Book Access profile (PBAP) is used to synchronize contacts between a remote device and the MC67. To establish an PBAP synchronization:

1. Ensure that Bluetooth is enabled and discoverable on both devices.
2. Ensure that the two devices are within 10 meters (32 feet) of one another.

3. Tap  > **Settings** > **Connection** > **Bluetooth** > **Devices**.
4. Tap **Add New Device**. The MC67 searches for a Bluetooth device, such as a Car Kit.
5. Select a device from the list.
6. Tap **Next**. The **Enter Passcode** window appears.

 **NOTE** If Smart-pairing is configured and the device is requesting one of the pre-defined PINs, the **Enter Passcode** window does not appear.
7. Enter the Passcode and the tap **Next**. The device is added to the Bluetooth list.
8. A dialog box appears requesting to transfer contacts to the car kit.
9. Select **Yes** or **No**.
10. If **Yes** is selected, contacts from the MC67 are transferred to the car kit.

Using Bluetooth StoneStreet One Bluetooth Stack

The following sections provide information on using the Stone Street One Bluetooth stack.

Turning the Bluetooth Radio Mode On and Off

Turn off the Bluetooth radio to save power or if entering an area with radio restrictions (e.g., an airplane). When the radio is off, other Bluetooth devices cannot see or connect to the MC67. Turn on the Bluetooth radio to exchange information with other Bluetooth devices (within range). Communicate only with Bluetooth radios in close proximity.

✓ **NOTE** To achieve the best battery life turn off radios not in use.

Disabling Bluetooth

To disable Bluetooth, tap the Connection icon on the Status bar and select **Wireless Manager** in the Connectivity dialog box. Tap the blue **Bluetooth** bar to turn off the Bluetooth radio.

Enabling Bluetooth

To enable Bluetooth, tap the Connection icon on the Status bar and select **Wireless Manager** in the Connectivity dialog box. Tap the blue **Bluetooth** bar to turn on the Bluetooth radio.

Modes

The BTE Explorer application has two modes for managing Bluetooth connections: Wizard Mode and Explorer Mode. The Wizard Mode is for novice Bluetooth users and the Explorer Mode is for experienced Bluetooth users. To switch between modes, select **View > Wizard Mode** or **View > Explorer Mode**.

Wizard Mode

Wizard Mode provides a simple process for discovering and connecting to Bluetooth devices.

✓ **NOTE** Switching between Wizard Mode and Explorer Mode closes all active connections.

Wizard Mode shows the devices and services in a simple Favorites view created by following the step-by-step wizard.

Explorer Mode

The **Explorer Mode** window is easy to navigate and provides greater control to users familiar with Bluetooth. The menu bar provides quick access to the options and tools used to connect to devices. To access Explorer Mode, tap **View > Explorer Mode**.

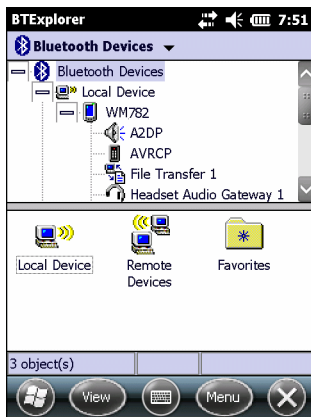

Figure 7-11 Explorer Mode Window

Use the “tap and hold” technique to view available options. Scroll bars and view options are similar to those on the Windows desktop. The tree structure lists the following sub-items:

- Local Device - This device
- Remote Device - Other Bluetooth devices
 - Trusted Devices - Bonded (paired) Bluetooth devices
 - Untrusted Devices - Discovered devices that are not bonded
- Favorites - Selected services that are set as *Favorite* for quick access.

✓ **NOTE** Switching between Wizard Mode and Explorer Mode closes all active connections.

Discovering Bluetooth Device(s)

The MC67 can receive information from discovered devices without bonding. However, once bonded, the MC67 and a bonded device exchange information automatically when the Bluetooth radio is turned on. See [Pairing with Discovered Device\(s\) on page 7-32](#) for more information.

To find Bluetooth devices in the area:

1. Ensure that Bluetooth is enabled on both devices.
2. Ensure that the Bluetooth device to discover is in discoverable and connectable modes.
3. Ensure that the require profile is enabled on the MC67. See [Profiles on page 7-41](#) for more information.
4. Ensure that the two devices are within 30 feet (10 meters) of one another.
5. Tap  > **Settings** > **Connections** > **Bluetooth**. The **BTE Explorer** window appears.

✓ **NOTE** If favorite connections have already been created, the **Favorites** screen displays. If no favorite connections have been created, the **New Connection Wizard** screen displays.

6. Tap **Menu** > **New Connection**. The **New Connection Wizard** appears.

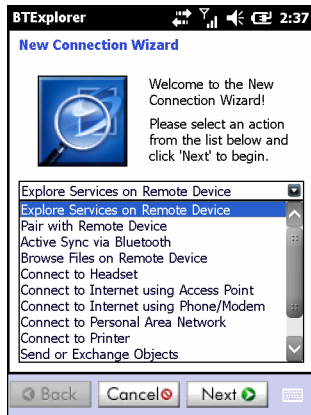

Figure 7-12 BTE Explorer Window

7. Select **Explore Services on Remote Device** or another from the drop-down list and tap **Next**.

✓ **NOTE** If a device discovery action has not been previously performed, a device discovery is automatically initiated. If a device discovery has previously been performed, the device discovery process is skipped, and the previously found list of devices displays. To start a new device discovery, tap and hold in the window and select **Discover Devices** from the pop-up menu.

8. **BTE Explorer** searches for Bluetooth devices in the area.



Figure 7-13 Discover Devices Dialog Box

The discovered devices display in the **Select Remote Device** window.



Figure 7-14 *Select Remote Device Window*

9. Select a device from the list and tap **Next**. The MC67 searches for services on the selected Bluetooth device.

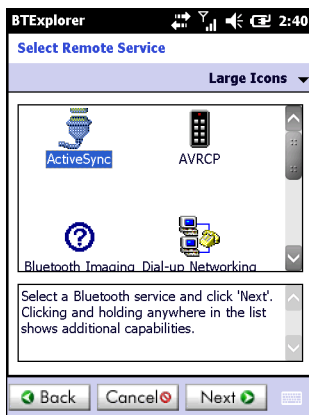

Figure 7-15 *Device Services*



NOTE If the MC67 discovers a service but the service is not supported, the service icon is grayed-out.

10. Select a service from the list and press **Next**. The **Connection Favorite Options** window appears.

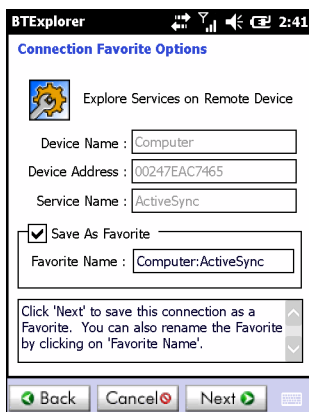

Figure 7-16 *Connection Favorite Options Window*

11. In the **Favorite Name** text box, enter a name for this service that will appear in the **Favorite** window.

12. Tap **Next**. The **Connection Summary** window appears.
13. Tap **Connect** to add the service to the **Favorite** window and connect to the service.

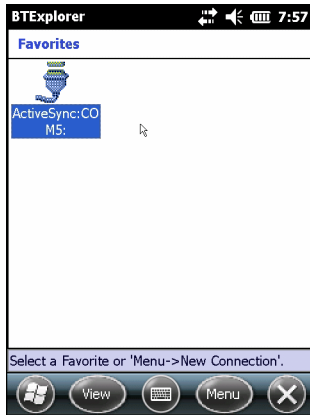

Figure 7-17 Favorites Window

Available Services

- ✓ **NOTE** Some devices might not require a PIN. This depends upon the device's authentication.

See the following sections for information on these services.

File Transfer Services

- ✓ **NOTE** Shared folders are a security risk.

To transfer files between the MC67 and another Bluetooth enabled device:

1. Ensure that OBEX File Transfer profile is enabled on the MC67. See [Profiles on page 7-41](#) for more information.

- ✓ **NOTE** If favorite connections have already been created, the **Favorites** screen displays. If no favorite connections have been created, the **New Connection Wizard** screen displays.

2. Use the **Connection Wizard** to search for a Bluetooth device.
3. Select the device and tap **Next**. The **Select Remote Service** window appears.
4. Select **File Transfer** and tap **Next**. The **Connection Favorite Options** window appears.
5. Tap **Next**. The **Connection Summary** window appears.
6. Tap **Connect**. The remote device's accessible folders appear.

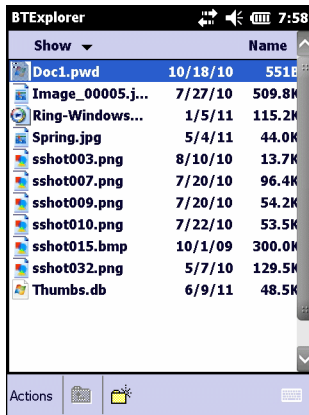

Figure 7-18 File Transfer Window

7. Double-tap the file to copy. The **Save Remote File** window appears.

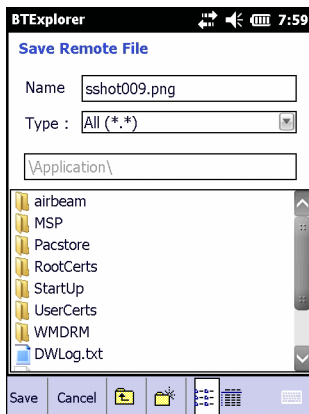

Figure 7-19 Save Remote File Window

8. Tap and hold on the file. A pop-up menu appears.

9. Select the action to perform:

- **New** - create a new file or folder on the remote device
- **Delete** - delete the selected file on the remote device.
- **Get File** - copy the file from the remote device to the MC67.
- **Put File** - copy a file from the MC67 to the remote device.

Creating a New File or Folder

To create a new folder or file on the remote device:

1. Tap and hold on the screen and select **New > Folder** or **New > File**. The **Create New Folder** or **Create New File** window appears.
2. Enter the name for the new folder or file.
3. Tap **OK** to create the new folder or file on the remote device.

Deleting a File

To delete a file from the remote device:

1. Tap and hold on the file to delete and select **Delete**.
2. In the **Delete Remote Device File** dialog box tap **Yes**.

Getting a File

To copy a file from a remote device:

1. Double-tap or tap and hold on the file and select **Get**. The **Save Remote File** window appears.
2. Navigate to the directory to save the file.
3. Tap **Save**. The file is transferred from the remote device to the MC67.

Copying a File

To copy a file to a remote device:

1. Tap **Action > Put**. The **Send Local File** window appears.
2. Navigate to the directory to save the file and select a file.
3. Tap **Open**. The file copies from the MC67 to the remote device.

Connecting to the Internet Using an Access Point

This section explains how to access a Bluetooth-enabled LAN access point (AP) for a network connection. Use Internet Explorer to connect to a server.

1. Ensure the MC67 is discoverable and connectable. See [Device Info on page 7-34](#).
2. Ensure that the **Personal Area Networking** profile is enabled on the MC67. See [Profiles on page 7-41](#) for more information.
3. Use the **Connection Wizard** to search for a Bluetooth AP.

✓ **NOTE** If favorite connections have already been created, the **Favorites** screen displays. If no favorite connections have been created, the **New Connection Wizard** screen displays.

4. Select the **Personal Area Network** or **Network Access** service and select **Connect** from the pop-up menu. The MC67 connects with the access point.
5. Tap  > **Internet Explorer**. The **Internet Explorer** window appears.
6. In the address field, enter an internet address and tap the **Enter** button. The web page loads.

✓ **NOTE** Network Access profile is not supported.

Dial-Up Networking Services

Dial-up networking allows the user to connect the MC67 to a Bluetooth Phone and use the Bluetooth Phone as a modem to connect to an office network or ISP.

Before setting up dial-up networking, obtain dial-up information and other necessary settings (username, password and domain name, if required) for the office network or ISP.

To create a new Bluetooth connection:

1. Ensure the Bluetooth Phone is discoverable and connectable.
2. Ensure that the **Dial-Up Networking** profile is enabled on the MC67. See [Profiles on page 7-41](#) for more information.
3. Tap **Menu > New Connection**.
4. Select **Explore Services on Remote Device** or another from the drop-down list and tap **Next**.
5. **BTE Explorer** searches for Bluetooth devices in the area.
The discovered devices display in the **Select Remote Device** window.
6. Select the Bluetooth Phone from the list and tap **Next**. The MC67 searches for services on the Bluetooth Phone.

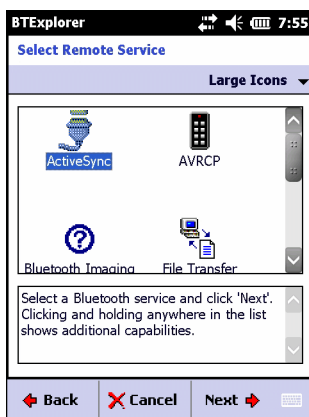

Figure 7-20 Select Remote Service Window

7. Select **Dial-up Networking Gateway** service from the list and tap **Next**. The **Connection Favorite Options** window appears.



Figure 7-21 Connection Favorite Options Window

8. In the **Favorite Name** text box, enter a name for this service that will appear in the **Favorite** window.
9. Tap **Next**. The **Connection Summary** window appears.
10. Tap **Connect**. The **Select Dial-up Networking Entry** window appears.

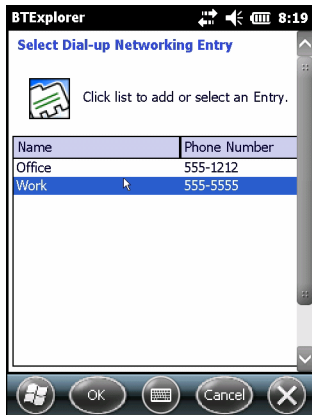

Figure 7-22 Select Dial-up Networking Entry Window

11. Select the entry and tap **OK**. The MC67 begins to communicate with the Bluetooth phone. If required, the phone requests permission to communicate with the MC67.
12. Confirm the connection on the phone. The **Network Log On** window appears.
13. In the **User name** text box, enter the user name for this connection.
14. In the **Password** text box, enter the password for this connection.
15. In the **Domain** text box, enter the domain name for this connection, if required.
16. Tap **Finish** or **Connect**.
17. The phone begins dialing and connects to the network.
18. To end a session, tap the **Connection** icon and then tap **Disconnect** in the dialog box.

Add a Dial-up Entry

To add a dial-up entry:

1. In the **Select Dial-up Networking Entry** window, tap and hold and then select **Add Entry** from the pop-up menu.

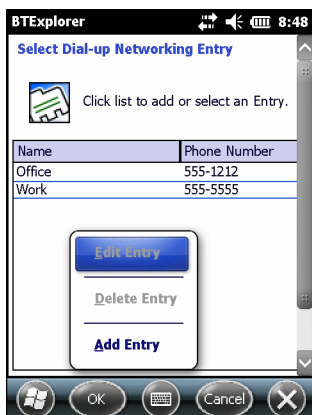

Figure 7-23 Select Dial-up Networking Entry Window

2. The **Add Phone Book Entry** window appears.

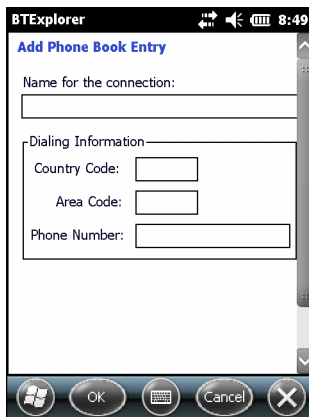

Figure 7-24 Add Phone Book Entry Window

3. In the Name for the connection text box, enter a name for this connection.
4. In the **Country Code** text box, enter the country code for the country that the user is calling.
5. In the **Area Code** text box, enter the area code.
6. In the **Phone Number** text box, enter the phone number.
7. Tap **OK**.

Object Exchange Push Services

Object Exchange (OBEX) is a set of protocols that allows sharing objects such as Contacts or pictures using Bluetooth.

To exchange contact information with another Bluetooth enabled device:

1. Ensure the MC67 is discoverable and connectable. See [Device Info on page 7-34](#).
2. Ensure that the **OBEX Object Push** profile is enabled on the MC67. See [Profiles on page 7-41](#) for more information.

✓ **NOTE** If favorite connections have already been created, the **Favorites** screen displays. If no favorite connections have been created, the **New Connection Wizard** screen displays.

3. Use the **Connection Wizard** to search for a Bluetooth device.
4. Select the device and tap **Next**.
5. Select the **OBEX Object Push** service and tap **Next**. The **Connection Favorite Options** window appears.
6. Tap **Next**. The **Connection Summary** window appears.
7. Tap **Connect**. The **OBEX Object Push** window appears.
8. In the **Action** drop-down list, select one of the following options: **Send Contact Information**, **Swap Contact Information**, **Fetch Contact Information**, or **Send a Picture**.

Sending a Contact

To send a contact to another device:

- ✓ **NOTE** Prior to sending and receiving contacts, a default contact must be set up before attempting to send a contact.

1. Tap and hold on **OBEX Object Push** and select **Connect**.

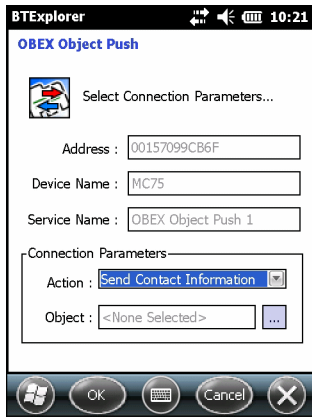



Figure 7-25 OBEX Object Push Window

2. In the **Action:** drop-down list, select **Send Contact Information**.
3. Tap .
4. Select a contact to send to the other device.
5. Tap **OK**.
6. Tap **OK** to send the contact to the other device and display a confirmation dialog box on the other device to accept the contact. A **Send Contact** dialog appears.
7. Tap **Ok**.

Swapping Contacts

To swap contacts with another device:

- ✓ **NOTE** Prior to swapping contacts, a default contact must be set up before attempting to send a contact.
Ensure that the MC67 is connectable.

1. Tap and hold on **OBEX Object Push** and select **Connect**. The **OBEX Object Push** window appears.

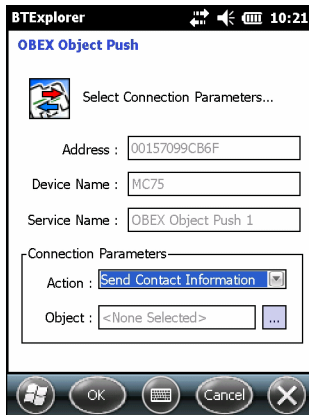

Figure 7-26 OBEX Object Push Window

2. In the **Action:** drop-down list, select **Swap Contact Information**.
3. Tap . The **Select Contact Entry** window appears.
4. Select a contact to send to the other device.
5. Tap **OK**.
6. Tap **OK** to swap contacts with the other device and display a confirmation dialog box on the other device to accept the contact.
7. Tap **Ok**.

Fetching a Contact

To fetch a contact from another device:

- ✓ **NOTE** Prior to sending and receiving contacts, a default contact must be set up before attempting to send a contact.

Ensure that the MC67 is connectable.

1. Tap and hold on **OBEX Object Push** and select **Connect**. The **OBEX Object Push** window appears.

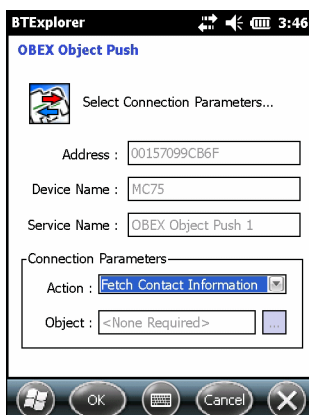

Figure 7-27 OBEX Object Push Window

2. In the **Action:** drop-down list, select **Fetch Contact information**.

3. Tap **OK**. The contact on the other device is copied.

Sending a Picture

To send a picture to another device:

1. Tap and hold on **OBEX Object Push** and select **Connect**. The **OBEX Object Push** window appears.

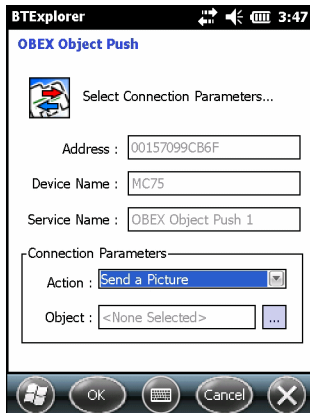



Figure 7-28 *OBEX Object Push Window*

2. In the **Action:** drop-down list, select **Send A Picture**.
3. Tap . The **Send Local Picture** window appears.

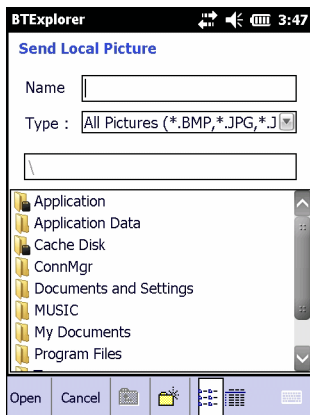

Figure 7-29 *Send Local Picture Window*

4. Navigate to the picture to send to the other device.
5. Tap **Open**.
6. Tap **OK** to send the picture to the other device and display a confirmation dialog box on the other device to accept the picture. A **Send Picture** dialog appears.
7. Tap **Ok**.

Headset Services

To connect to a Bluetooth headset:

✓ **NOTE** Newer Bluetooth headsets are device dependant and remember the last device they connected to. If problems occur while connecting to the headset, place the headset in discovery mode. Refer to the headset user manual for more information.

1. Ensure the MC67 is connectable (required when automatic re-connect is initiated). See [Device Info on page 7-34](#).
2. Ensure that the **Headset** profile is enabled on the MC67. See [Profiles on page 7-41](#) for more information.
3. Use the **Connection Wizard** to search for a Bluetooth headset.
4. Select the device and tap **Next**.
5. Select the **Headset** service name and select **Connect**. The MC67 connects to the headset. Refer to the headset user manual for instructions on communicating with a Bluetooth device.

✓ **NOTE** When using a Bluetooth headset with Headset Services, the user cannot accept or end a call from the headset. The user must accept or end a call on the MC67.

6. Press the communication button on the headset. This routes both system and WAN call audio to the headset.
7. When a call is received on the MC67, tap the **Accept** button to answer the call.
8. Press the communication button on the headset to route the audio back to the MC67.

Serial Port Services

Use the wireless Bluetooth serial port connection as a physical serial cable connection. Configure the application that will use the connection to the correct serial port.

To establish a serial port connection:

1. Use the **Connection Wizard** to search for a Bluetooth serial device.
2. Select the device and tap **Next**. The **Connection Favorite Options** window appears.
3. In the **Local COM Port:** drop-down list select a COM port.
4. Tap **Finish**.

ActiveSync Using Serial Port Services

✓ **NOTE** By default, COM ports COM5, COM9, COM11, COM21, COM22 and COM23 are Bluetooth virtual ports. If an application opens one of these ports, the Bluetooth driver activates and guides the user through a Bluetooth connection.

Use the wireless Bluetooth serial port connection for ActiveSync just as a physical serial cable connection. Configure the application that will use the connection to the correct serial port.



Figure 7-30 ActiveSync Connection Settings Window on PC

To establish an ActiveSync connection:



NOTE When creating an ActiveSync connection, only use StoneStreet One Bluetooth Explorer in Wizard mode.

1. Use the **Connection Wizard** to search for a Bluetooth device, such as a computer. In the drop-down list select **ActiveSync via Bluetooth**.
2. Select the device and tap **Next**. The **Connection Favorite Options** window appears.
3. Tap **Connect**. The **Remote Service Connection** window appears.

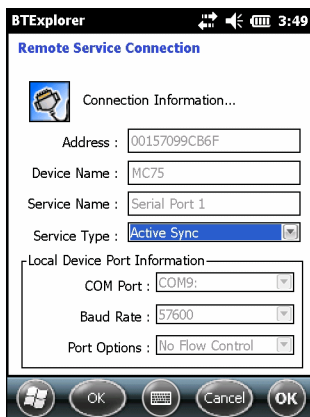

Figure 7-31 Remote Service Connection Window

4. In the **Service Type** drop-down list, select **Active Sync**.
5. Tap **OK**. The MC67 connects the PC and an ActiveSync session begins.
6. Tap **Finish**. The Connection Favorite Options window appears.
7. To end the session, tap the ActiveSync icon in the **Favorite** window and select **Disconnect** from the pop-up window.

Personal Area Network Services

✓ **NOTE** This profile supports Ad-hoc and PAN User. Network Access Profile is not supported.

Connect two or more Bluetooth devices to share files, collaborate, or play multi-player games. To establish a Personal Area Network connection:

1. Ensure that the **Personal Area Networking** profile is enabled on the MC67. See [Profiles on page 7-41](#) for more information.
2. Use the **Connection Wizard** to search for a Bluetooth device.
3. Select the device and tap **Next**. The **Connection Favorite Options** window appears.
4. Tap **Next**. The **Connection Summary** window appears.
5. Tap **Connect**. The MC67 connects to the Bluetooth device.

A2DP/AVRCP Services

A2DP/AVRCP is used to connect to a high-quality stereo headset:

1. Ensure the MC67 is connectable (required when automatic re-connect is initiated). See [Device Info on page 7-34](#).
2. Ensure that the remote Bluetooth device is in discoverable mode. See the devices user manual for instructions.
3. Ensure that the **A2DP/AVRCP** profile is enabled on the MC67. See [Profiles on page 7-41](#) for more information.
4. Tap **Menu > New Connection**.
5. Select **Connect to High-Quality Audio** from the drop-down list.
6. Tap **Next**.
7. Select the device and tap **Next**.
8. Enter the PIN Code for the remote device and then tap **OK**. The **Connection Favorite Options** window appears.
9. Tap **Next**.
10. Tap **Connect**. The MC67 connects to the high-quality audio headset.

For stereo headsets that can use hands-free services, connect to the hands-free service after connecting to the A2DP service:

1. Tap **Menu > New Connection**.
2. Select **Connect to Headset** from the drop-down list.
3. Tap **Next**.
4. Select the stereo headset and tap **Next**.
5. Select the **Hands-Free unit** service and then tap **Next**.
6. Tap **Next**.

7. Tap **Connect**.

Connect to a HID Device

The MC67 can connect to an Human Interface Device (HID) device such as a Bluetooth keyboard:

1. Ensure the MC67 is connectable (required when automatic re-connect is initiated). See [Device Info on page 7-34](#).
2. Ensure that the remote Bluetooth device is in discoverable mode. See the device user manual for instructions.
3. Ensure that the **HID Client** profile is enabled on the MC67. See [Profiles on page 7-41](#) for more information.
4. Tap **Menu > New Connection**.
5. Select **Explore Services on Remote Device** from the drop-down list.
6. Tap **Next**.
7. Select the device and tap **Next**.
8. Select the service and tap **Next**.
9. The **Connection Favorite Options** window appears.
10. Tap **Next**.
11. Tap **Connect**. The MC67 connects to the HID device.

Pairing with Discovered Device(s)

A pair is a relationship created between the MC67 and another Bluetooth device in order to exchange information in a secure manner. Creating a pair involves entering the same PIN on both devices. After creating a pair and turning on the Bluetooth radios, the devices recognize the pair and can exchange information without re-entering a PIN.

To pair with a discovered Bluetooth device:

- ✓ **NOTE** If favorite connections have already been created, the **Favorites** screen displays. If no favorite connections have been created, the **New Connection Wizard** screen displays.

1. Tap  > **Settings > Connections > Bluetooth**. The **BTEplorer** window appears.
2. Tap **Menu > New Connection**. The **New Connection Wizard** window appears.
3. In the drop-down list, select **Pair with Remote Device**.
4. Tap **Next**. The **Select Remote Device** window appears.

- ✓ **NOTE** Devices discovered previously are listed to save time. To start a new device discovery, tap and hold on the list area and select **Discover Devices** from the pop-up menu.



Figure 7-32 *Select Remote Device Window*

5. Select a device from the list and tap **Next**. The **PIN Code Request** window appears.

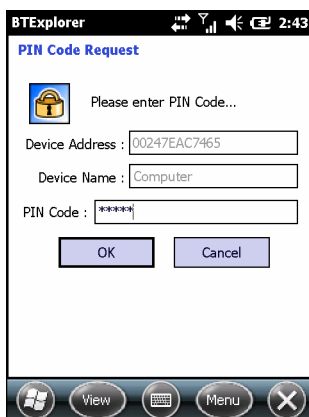

Figure 7-33 *PIN Request Window*

6. In the **PIN Code** field, enter the PIN code.
7. Tap **OK**. The **Pairing Status** window displays.
8. Tap **Finish**. The devices are successfully paired. The device name moves to the **Trusted Devices** window.

Deleting a Paired Device

To delete a device no longer needed:

1. Tap the **Bluetooth** icon and select **Show BTE Explorer**. The **BTE Explorer** window appears.
2. Tap **Menu > Trusted Devices**. The **Trusted Devices** window appears.
3. Tap and hold on the device select **Delete Link Key** in the pop-up menu.
4. A confirmation dialog appears. Tap **Yes**.

Accepting a Pairing

When a remote device wants to pair with the MC67, enter a PIN when requested to grant permission.

1. Ensure that the MC67 is set to discoverable and connectable. See [Bluetooth Settings on page 7-34](#). When prompted to bond with the remote device the **PIN Code Request** window appears.



Figure 7-34 PIN Code Request Window

2. In the **PIN Code:** text box, enter the same PIN entered on the device requesting the bond. The PIN must be between 1 and 16 characters.
3. In the **Device Name:** text box, edit the name of the device requesting the bond, if desired.
4. Tap **OK** to create the bond. The MC67 can now exchange information with the other device.

Bluetooth Settings

Use the **BTE Explorer Settings** window to configure the operation of the **BTE Explorer** application. Tap **Menu > Settings**.

Device Info

Use **Device Info** to configure the MC67's Bluetooth connection modes.

Table 7-3 Device Info Data

Item	Description
Device Name	Displays the name of the MC67.
Discoverable Mode	Select whether or not the MC67 is discoverable by other Bluetooth devices.
Connectable Mode	Select whether or not the MC67 is connectable by other Bluetooth devices.

Services

- ✓ **NOTE** Ensure that the MC67 is discoverable and connectable when remote devices use MC67 services.

Use **Services** to add or delete Bluetooth services.

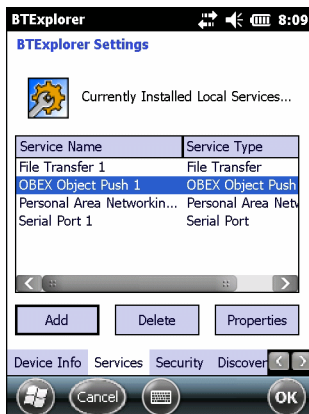

Figure 7-35 BTE Explorer Settings - Services

To add a service:

1. Tap **Add**.

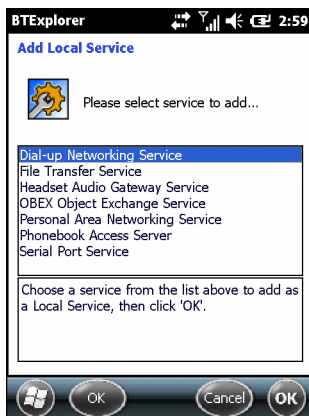

Figure 7-36 Add Local Service Window

2. In the list, select a service to add.
3. Tap **OK**. The **Edit Local Service** window displays for the selected service.
4. Select the appropriate information and then tap **OK**. See the following sections for information on the available services.

Dial-Up Networking Service

Dial-up Networking allows other Bluetooth devices to access a dial-up modem.

Table 7-4 Dial-up Networking Information Data

Item	Description
Service Name	Displays the name of the service.
Service Security	Select the type of security from the drop-down list. Options are None , Authenticate , or Authenticate/Encrypt .

Table 7-4 *Dial-up Networking Information Data*

Item	Description
Local COM Port	Select the COM port.
Local Baud Rate	Select the communication baud rate.
Local Port Options	Select the port option.

File Transfer Service

File transfer allows other Bluetooth devices to browse files.

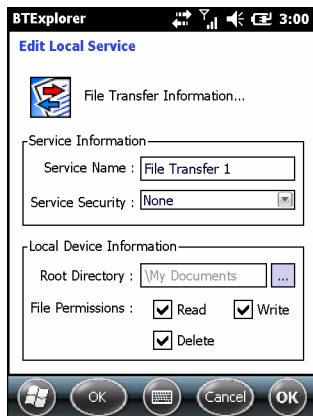
**Figure 7-37** *BTE Explorer Settings - File Transfer Information***Table 7-5** *File Transfer Information Data*

Item	Description
Service Name	Displays the name of the service.
Service Security	Select the type of security from the drop-down list. Options are None , Authenticate , or Authenticate/Encrypt .
Root Directory	Select the directory that other Bluetooth devices can access.
File Permissions	Select the file permissions for the selected directory. Check the appropriate box to grant read access, write access, and delete access.

Hands-Free Audio Gateway Service

Hands-Free Service Audio Gateway allows connection to hands-free devices.

Table 7-6 *Hands-Free Audio Gateway Data*

Item	Description
Service Name	Displays the name of the audio service.

Headset Audio Gateway Service

Headset Service Audio Gateway allows connection to headset devices.

Table 7-7 *Headset Audio Gateway Data*

Item	Description
Service Name	Displays the name of the audio service.

IrMC Synchronization Service

The IrMC Synchronization service used to synchronize PIM contacts between a remote device and the MC67.

Table 7-8 *IrMC Synchronization Data*

Item	Description
Service Name	Displays the name of the service.
Service Security	Select the type of security from the drop-down list. Options are None , Authenticate , or Authenticate/Encrypt .
Phonebook	Select the Phonebook checkbox to allow synchronization with the MC67's contacts.
	Select Read , Write , Create and/or Delete to allow phonebook permissions.
Calendar	Select the Calendar checkbox to allow synchronization with the MC67's calendar.
	Select Read , Write , Create and/or Delete to allow calendar permissions.

OBEX Object Exchange Service

OBEX Object Exchange allows other Bluetooth devices to push contacts, business cards, pictures, appointments, and tasks to the MC67.

Table 7-9 *OBEX Exchange Information Data*

Item	Description
Service Name	Displays the name of the service.
Service Security	Select the type of security from the drop-down list. Options are None , Authenticate , or Authenticate/Encrypt .
Business Card	Select Contact entry.
Do not allow clients to push objects	Disables clients from pushing objects to the MC67.
Inbox Directory	Select a directory where another Bluetooth device can store files.

Personal Area Networking Service

Personal Area Networking hosts a Personal Area Network which allows communication with other Bluetooth devices.

Table 7-10 *Personal Area Networking Data*

Item	Description
Service Name	Displays the name of the service.
Service Security	Select the type of security from the drop-down list. Options are None , Authenticate , or Authenticate/Encrypt .
Support Group Ad-Hoc Networking	Select to enable Ad-Hoc networking.

Serial Port Service

Serial port allows other Bluetooth devices to access COM ports.

Table 7-11 *Serial Port Services Data*

Item	Description
Service Name	Displays the name of the service.
Service Security	Select the type of security from the drop-down list. Options are None , Authenticate , or Authenticate/Encrypt .
Local COM Port	Select the COM port.
Local Baud Rate	Select the communication baud rate.
Local Port Options	Select the port option.

A2DP Service

Advanced Audio Distribution (A2DP) hosts connects from Bluetooth devices supporting high-quality stereo audio.

Table 7-12 *Advanced Audio Distribution Data*

Item	Description
Service Name	Displays the name of the audio service.

AVRCP Service

Audio Video Remote Control (AVRCP) hosts connections from Bluetooth devices supporting audio remote-control functionality.

Table 7-13 *Audio Video Remote Control Data*

Item	Description
Service Name	Displays the name of the audio service.

Security

Security settings allows the user to set global security policies for Bluetooth. Note that these settings are only active on local Services that are set to Authenticate or Authenticate/Encryption. The user can set authentication on local Services under Services.

To adjust the security settings for an individual service, select **Services** first, then select the individual service, then **Properties**.



Figure 7-38 BTE Explorer Settings - Security

✓ **NOTE** To use PIN Code, select **Authenticate** or **Authenticate/Encrypt** from the Service Security drop-down list on each local service.

Table 7-14 Security Data

Item	Description
Use PIN Code (Incoming Connection)	Select for automatic use of the PIN code entered in the PIN Code text box. It is recommended not to use this automatic PIN code feature. See Security on page 7-2 for more information.
PIN Code	Enter the PIN code.
Encrypt Link On All Outgoing Connections	Select to enable or disable encryption on all outgoing connections to other Bluetooth devices.

Discovery

Use **Discovery** to set and modify discovered devices.

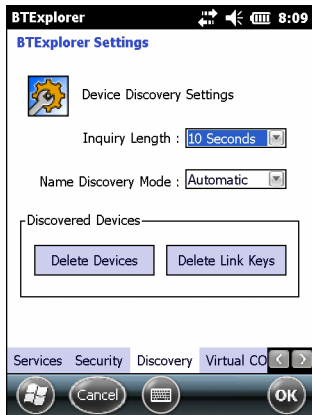

Figure 7-39 BTE Explorer Settings - Discovery

Table 7-15 Discovery Data

Item	Description
Inquiry Length	Sets the amount of time the MC67 takes to discover Bluetooth devices in the area.
Name Discovery Mode	Select either Automatic or Manual to automatically attempt to discover a Bluetooth device's name after finding the device.
Discovered Devices - Delete Devices	Deletes all discovered devices and link keys from memory.
Discovered Devices - Delete Linked Keys	Removes all pairing from remote Bluetooth devices, and makes them all un-trusted.

Virtual COM Port

Virtual COM Port defines which COM ports BTE Explorer attempts to use for virtual COM ports. Check the appropriate checkbox to use the port as a virtual COM port. When finished, choose **Apply** to enforce changes, or **Revert** to restore the original settings.

Table 7-16 Virtual COM Port Data

Item	Description
COM5:Bluetooth	Enable or disable COM Port 5.
COM9:Bluetooth	Enable or disable COM Port 9.
COM11:Bluetooth	Enable or disable COM Port 11.
COM21:Bluetooth	Enable or disable COM Port 21.
COM22:Bluetooth	Enable or disable COM Port 22.
COM23:Bluetooth	Enable or disable COM Port 23.

HID

Use **HID** to select The Human Interface Device Profile programming interface that defines the protocols and procedures to be used to implement HID capabilities.

Provides support for devices such as mice, joysticks, keyboards.

Table 7-17 *HID Data*

Item	Description
Enable Key Repeat	Enables key repeat functionality.
Delay	To increase key repeat delay, drag the Delay slider to the right. To decrease key repeat delay, drag the Delay slider to the left.
Rate	To increase key repeat speed, drag the Rate slider to the left. To decrease key repeat speed, drag the Rate slider to the right.

Profiles

Use **Profile** to load or remove Bluetooth services profiles. If a profile is not used, it can be removed to save memory.

1. Tap a check box next to the profile to load (activate).
The Serial Port profile is always active and cannot be removed.
2. Tap **Select All** to select all profiles or tap **Deselect All** to deselect all profiles.
3. Tap **Apply** to activate the profiles and then **Close** to exit the application.

System Parameters

Use **System Parameters** to set device connection settings.

Table 7-18 *System Parameters Data*

Item	Description
Page Timeout	Sets the amount of time the MC67 searches for a device before moving on the next device.
Link Supervision Timeout	Sets the amount of time that the MC67 will wait for a device to come back into range after it has gone out of range. If the device does not come back into range by the set time, the MC67 drops the connection.

Miscellaneous

Use **Miscellaneous** to set color and types to better view active connections.

Table 7-19 *Miscellaneous Data*

Item	Description
Highlight Connections	Select the connection type to highlight when connected. In the Wizard Mode, the only options are <i>Favorites</i> or <i>None</i> . In the Explorer Mode the options are None , Tree View Only , List View Only , or Tree and List View .
Apply Text Style	Select the text style to apply to the connection text.
Apply Text Color	Select the text color to apply to the connection text.

CHAPTER 8 USING GPS NAVIGATION

Introduction

The MC67 includes Global Positioning System (GPS) technology. GPS technology is based on a worldwide system of GPS satellites orbiting the earth that continuously transmit digital radio signals. These radio signals contain data on the satellites' locations and their exact clock time and are used to determine the user location on the earth.



WARNING! When using the MC67 in a vehicle, it is the user's responsibility to place, secure and use in a manner that will not cause accidents, personal injury or property damage or obstruct their view. It is the responsibility of the driver to operate the vehicle in a safe manner, maintain observation of all driving conditions at all times, and not become distracted by the device to the exclusion of safe driving practices. It is unsafe to operate the controls of the device while driving.

Software Installation

Third-party GPS navigation software is required. Evaluation software is available from various suppliers. For example; VisualGPS, visit: <http://www.visualgps.net/VisualGPSce/>

If interested in purchasing GPS navigation software check with the GPS software vendor (before purchasing, downloading, or installing any software) to determine that the application is compatible with the MC67. Refer to the application's user guide for application installation and setup information.

MC67 GPS Setup

The GPS-enabled MC67 automatically manages access to the GPS receiver to allow multiple programs to simultaneously access GPS data.

By default, the MC67 has the following settings:

1. Tap  > **Settings** > **System** > **External GPS**.
2. In the **Programs** tab, the **GPS program port** is set to **COM8**.

3. In the **Hardware** tab, the **GPS hardware port** is set to **None**.

Operation

Acquiring satellite signals may take several seconds to a few minutes. It is best to be outside and have a clear, unobstructed view of the sky. Without a clear view, acquisition takes much longer and could result in the MC67 being unable to compute the initial position quickly. When operating the device indoors access to the GPS signals may be limited or unavailable.

✓ **NOTE** When using a GPS navigation application, ensure that the MC67 does not go into suspend mode. If the MC67 suspends then the power to the GPS radio is removed. Upon resume the GPS receiver must reacquire a valid GPS signal, resulting in a delay of positional information.

GPS Maps on microSD Cards

GPS navigation software vendors may sell maps on microSD cards. If using a microSD card with the GPS navigation software install the microSD memory card using procedure in [Installing a microSD Card on page 1-2](#).

Answering a Phone Call While Using GPS

If receiving an incoming phone call while using GPS navigation software:

1. Answer the phone call by pressing the **Answer** button.
2. Once the phone call ends, press the **End Call** button to resume the audio on the GPS software.

✓ **NOTE** Anytime using GPS on the MC67 and the user receives a phone call, the audio on the GPS navigation software is muted until the user finishes the call.

Losing the GPS Signal While in a Vehicle

GPS performance on the MC67 may be affected if the vehicle has thermal glass windows and windshields, which can block the MC67 from receiving a GPS signal from satellites. To improve GPS signal strength, place the MC67 where there is a clear view of the sky. A direct line of sight is required between the MC67 and the GPS satellites to access information from the satellites.

Assisted GPS

GPS can be used in stand-alone or Assisted GPS (A-GPS) modes. A Stand-alone GPS receiver downloads data from GPS satellites. It can take several minutes to get a fix. By using GPS Location servers, A-GPS dramatically improves the performance of the Time To First Fix (TTFF) of GPS receivers by providing them with data that they would ordinarily have to download from the GPS satellites and other aiding data that helps the acquisition. With the A-GPS data, GPS receivers can operate faster and more reliably.

A-GPS follows the Secure User Plane Location (SUPL) protocol which allows the MC67 to communicate with a location server.

To configure SUPL on the MC67:

1. Tap  > **Settings** > **System** > **GPS Setup** icon.

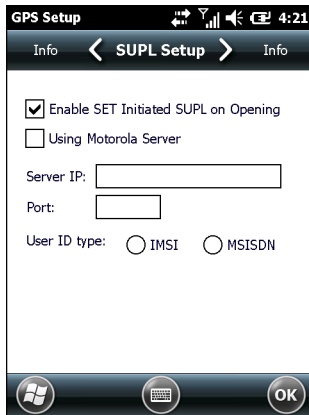

Figure 8-1 SUPL Setup Tab

2. Select **Enable SET Initiated SUPL on Opening** to enable the MC67 to initiate SUPL upon opening the GPS port.
3. Select **Using Motorola Server** to use the Motorola SUPL server.
4. Enter the SUPL Server IP address in the **Server IP** field. The server IP address is not required when using the Motorola server.
5. Enter the SUPL Server port number in the **Port** field. The port number is not required when using the Motorola server.
6. **User ID type** is to choose which ID type to use during the SUPL session. This option is not available when using the Motorola server.







CHAPTER 9 SETTINGS

This chapter provides information for customizing the MC67.

Settings Folder

Table 9-1 lists setting applications pre-installed on the MC67. Tap  > **Settings** to open the **Settings** tab.

Table 9-1 *Setting Applications*

Icon	Description	Icon	Description
	Clock & Alarms - Set the device clock to the date and time of the current location. Alarms can also be set at specified days and times of a week.		Lock - Set a password for the MC67.
	Home - Customize the appearance of the Home screen and the information to display on it.		Sounds & Notifications - Enable sounds for events, notifications, and more, and set the type of notification for different events.
	Connections Folder - Contains connection setting applications.		System Folder - Contains system setting applications.
	Personal Folder - Contains personal setting applications.		

Connections Folder

	Beam - Set the MC67 to receive incoming IrDA beams.		Connections - Set up one or more types of modem connections for the device, such as phone dial-up, cellular, Bluetooth, and more, so that the MC67 can connect to the Internet or a private local network.
---	--	---	---

Table 9-1 *Setting Applications (Continued)*































Icon	Description	Icon	Description
	Bluetooth - Turn on Bluetooth, set the MC67 to visible mode and scan for other Bluetooth devices in the area.		Domain Enroll - Make the device an AD domain member for device management and security.
	Wi-Fi - Setup wireless network connection and customize settings.		USB to PC - Need info
	Wireless Manager - Enables or disables the MC67's wireless radios and customizes Wi-Fi, Bluetooth and Phone settings.		
Personal Folder			
	Buttons - Assign a program to a button.		Phone - Configure the phone.
	Owner Information - Enter personal information on the MC67.		
System Folder			
	About - View basic information such as the Windows Embedded handheld version and type of processor used on the MC67.		Certificates - See information about certificates installed on the MC67.
	Backlight - Set backlight settings. Refer to Backlight Settings on page 9-5 .		Customer Feedback - Submit feedback on the Windows Mobile 6 software.
	Encryption - Allow files on a storage card to be encrypted. Encrypted files are readable only on the device.		DataWedge - Enable data capture using the camera or imager.
	Error Reporting - Enable or disable the Microsoft's error reporting function.		GPS Setup - View GPS SUPL information. See MC67 GPS Setup on page 8-1 .
	External GPS - Set the appropriate GPS communication ports, if required. Refer to MC67 GPS Setup on page 8-1 .		IST Settings - Set the appropriate setting for configuring the MC67's Interactive Sensor Technology. Refer to IST Settings on page 9-8 .
	Managed Programs - Displays the programs that were installed on the MC67 using Mobile Device Manager.		Keypad Backlight - Set the keypad backlight time-out. Refer to Keypad Backlight Settings on page 9-5 .
	Memory - Check the device memory allocation status and memory card information and stop currently running programs.		Power - Check battery power and set the time-out for turning off the display to conserve battery power. Refer to Power Settings on page 9-4 .

Table 9-1 *Setting Applications (Continued)*

Icon	Description	Icon	Description
	Phone Info - Displays the MC67's software and hardware information.		Regional Settings - Set the regional configuration to use, including the format for displaying numbers, currency, date, and time on the MC67.
	Screen - Change the screen orientation, re-calibrate the screen, and change the screen text size.		Remove Programs - Remove programs that were installed on the MC67.
	System Info - Obtain system information.		UI Settings - Set Start screen layout and IE zoom feature. Refer to UI Settings on page 9-6 .
	Task Manager - Stop running programs.		USBConfig - Configure the MC67 USB port. Refer to USB Configuration on page 9-5 .

Locking the MC67

Use the **Password** window to set a password to disable unauthorized access to the MC67.

- ✓ **NOTE** If the device is configured to connect to a network, use a strong (difficult to figure out) password to help protect network security. Password cracking tools continue to improve and the computers used to crack passwords are more powerful than ever.

If the user enters an incorrect password eight times, the user is requested to enter a code before trying again.

If the user forgets the password, contact the system administrator.

1. Tap  > **Settings** > **Lock**.

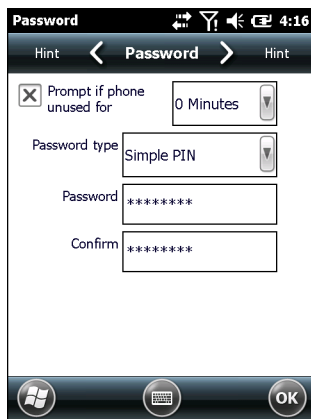

Figure 9-1 Password Window

2. Select **Prompt if device unused for** check box to enable password protection.
3. From the drop-down list, select a time value for the protection to take affect after non-use.
4. From the **Password type:** drop-down list, select either **Simple PIN** or **Strong alphanumeric**.
5. For a simple password, enter a four-digit password in the **Password** field.
For a stronger password:
 - a. Enter a seven character password in the **Password:** field. A strong password must contain at least seven characters and contain at least three of the following: uppercase and lowercase letters, numerals, and punctuation.
 - b. Re-enter the password in the **Confirm:** field.
6. Tap **OK**.
7. Tap **OK**.

Power Settings

To set the MC67 to turn off after a short period of non-use:

1. Tap  > **Setting** > **System** > **Power**.

2. Tap the **Advanced** tab.
3. Select the **On battery power: Turn off device if not used for** check box and select a value from the drop-down list.
4. Select **OK**.

Backlight Settings

To change the backlight settings:

1. Tap  > **Settings** > **System** > **Backlight** > **Battery Power** tab.
2. Select the **Disable backlight if device is not used for** check box and select a value from the drop-down list.
3. Select the **Brightness** tab.
4. Tap the **Backlight Auto Mode** check box to disable auto mode.
5. Tap the **Disable backlight** check box to turn off the display backlight, or use the slider to set a low value for the backlight.
6. Tap the **Persist 'Disable backlight' setting over reset** check box to enable the settings to persist after a reset.
7. Tap **OK**.

Keypad Backlight Settings

To change the keypad backlight settings:

1. Tap  > **Settings** > **System** > **Keypress** > **Battery Power** tab.
2. Select the **Disable keylight if device is not used for** check box and select a value from the drop-down list.
3. Select the **Advanced** tab.
4. Tap the **Keylight Auto Mode** check box to disable auto mode.
5. Tap the **Disable keylight** check box to turn off the keypad backlight.
6. Tap the **Persist 'Disable keylight' setting over reset** check box to enable the settings to persist after a reset.
7. Tap **OK**.

USB Configuration

The MC67 can be placed into any of the following USB modes:

- **USB Client** - Sets the MC67 to USB Client mode.
- **USB Host** - Sets the MC67 to USB Host mode.

- **USB On-the-Go** - Sets the MC67 to automatically determine necessary mode (default).

To place the MC67 into one of these modes:

1. Tap  > **Settings** > **System** > **USBConfig**.
2. Select one of the USB radio buttons.
3. Tap **OK**.

UI Settings

Use the **UI Settings** application to change the grid view in the **Start** screen and to control Zooming in Internet Explorer.

Start Screen Settings

To change the grid view of the **Start** screen:

1. Tap **Start**> **Settings** > **System** > **UI Settings**.
2. Tap the **Start Screen Settings** tab.

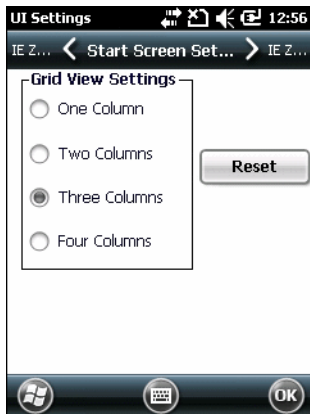

Figure 9-2 *Start Screen Settings Tab*

3. Select the number of columns.
4. Tap **OK**.

✓ **NOTE** Tap **Reset** to return to the default **3 Column** setting.

5. Tap **OK**.
6. Perform a warm boot.

IE Zoom Mapping

When Internet Explorer opens, the volume keys on the side of the MC67 are used to zoom in and out. To disable IE Zoom Mapping:

1. Tap  > **Settings** > > **System** > **UI Settings**.

2. Tap the **IE Zoom Mapping** tab.

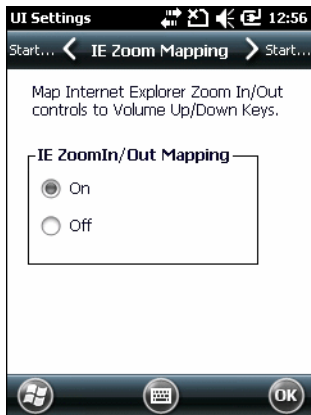

Figure 9-3 *IE Zoom Mapping Tab*

3. Select **Off**.
4. Tap **OK**.
5. Tap **OK** to turn off mapping.

IST Settings

IST Control Panel Applet is an applet which needs to configure all the system wide actions based on IST sensor events and data. It provides a means to view version information of all the components used in the sensor system, change Display settings, to configure power management activity, Events notification and Sensors view. Also it provides facility to visualize sensor data in different ways and configurations required for sensors such as setting sensor threshold values, sensor calibration and etc.

Info Tab

Use the **IST Info** tab to view IST software version information.



Figure 9-4 *IST Info Tab*

Display Tab

Use the **Display** tab configure display interaction settings.

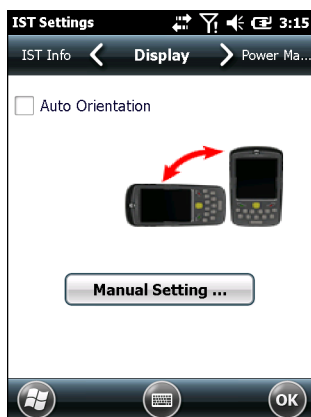

Figure 9-5 *Display Tab*

The Auto Orientation parameter controls the display rotation according to the MC67 orientation. Select the **Auto Orientation** checkbox to enable this feature. Auto orientation is disabled by default. To manually set the screen orientation, tap the **Manual Setting** button.

Power Management Tab

Use the **Power Management** tab to configure power management settings.

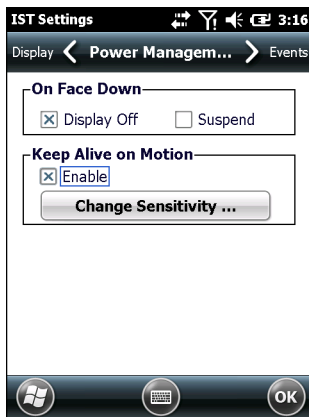

Figure 9-6 Power Management Tab

On Face Down

The **On Face Down** section provides configurable options to control what happens when the MC667 is placed with the display face down.

Select the **Display Off** checkbox to turn off the backlight when the MC67 is placed face-down. The backlight automatically powers on when the MC67 is tuned face-up.

Select the **Suspend** checkbox to suspend the MC67 when it placed face-down. To wake the MC67 use the controls listed in the **Wake Up on Motion** section below.

Keep Alive On Motion

Select the **Enabled** checkbox to prevent the MC67 from going into suspend mode while it is in motion. The motion sensitivity is configurable. To set the sensitivity, tap the **Change Sensitivity** button.

- ✓ **NOTE** There is no time out defined for suspend due to IST inactivity. To aggressively manage power, while there is no motion, set the MC67 suspend time out to a very short time using system power settings. This setting suspends the MC67 when there is no motion activity or any other activity within this set time out.

Setting Sensitivity

Use the slider to set the sensitivity. A low setting indicates that a harder shake (faster movement) is required for the IST to initiate a wake up action. The sensitivity can be set from “0” to “10” and when the sensitivity is set to lower values a simple shake/motion can be detected by IST. A high setting allows IST to issue a wake up action when an easier movement to the MC67 is detected. Shake the MC67 to test the set sensitivity. An audio sound is heard and a message is displayed on screen when the shaking level reaches the set sensitivity level.

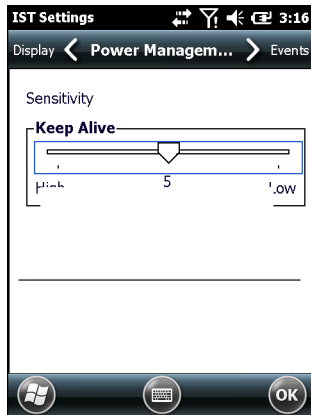

Figure 9-7 Set IST Sensitivity Window

Events Tab

Use the **Event** tab to enable or disable free fall sound and facilitates to set the free fall sound file as desired.

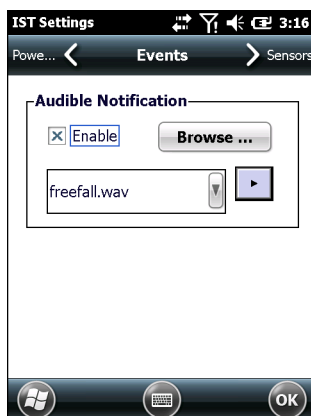

Figure 9-8 Event Window

Use the Audible Notification panel to enable playing of a wave file when the MC67 is dropped. Select a desired .wav file from the Sounds: drop-down list.

Sensors Tab

The **Sensor** tab displays all the sensors available in the MC67:

- Orientation - displays the orientation of the MC67 in pictorial and graphical views.
- Motion - detects High G or Free Fall of the device. Value 0 is no motion detected. When a Free Fall is detected sensor Visualize window will play a wave with highest amplitude.
- Acceleration - displays device acceleration along the X, Y and Z axis.
- Tilt Angle - Provide angular rotation with respect to the horizontal plane.
- ALS - Provides light intensity variation with time.
- eCompass - displays the device's rotation with respect to the earth's magnetic north.

Tap a sensor icon to display the sensor information screen. Sensor data can be viewed in Graphical or Visual mode. Sensor Calibration is provided in Settings button if supported.

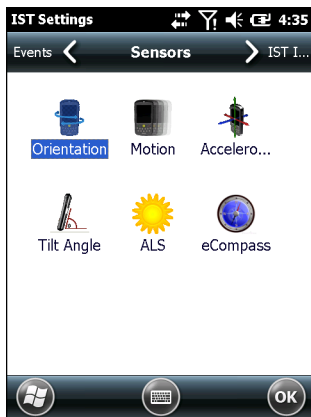

Figure 9-9 Sensors Tab

The following sensor information displays for each sensor.

- Sensor Name
- Sensor ID
- Range
- Unit
- Scale
- Connectivity
- Device status.

The **Setting** button shows if the selected sensor has any parameter that is user configurable including calibration (if supported). This screen is specific to a particular sensor.

Tap **Visualize** to display sensor in a pictorial view.

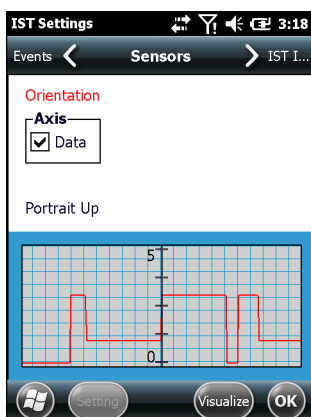

Figure 9-10 Visualize Screen Example

1.

CHAPTER 10 ACCESSORIES

Introduction

MC67 accessories, listed below, provide a variety of product support capabilities.

Accessories

Table 10-1 lists the accessories available for the MC67.

Table 10-1 MC67 Accessories

Accessory	Part Number	Description
Cradles		
Single Slot USB Cradle	CRD5500-1000UR	Charges the MC67 main battery and a spare battery. Synchronizes the MC67 with a host computer through a USB connection.
Single Slot Ethernet/Modem/USB Cradle	CRD5500-1000XR	Charges the MC67 main battery and a spare battery. Synchronizes the MC67 with a host computer through an Ethernet, Modem or USB connection.
Four Slot Charge Only Cradle	CRD5500-4000CR CRD5501-4000CR	Charges up to four MC67 devices.
Four Slot Ethernet Cradle	CRD5500-4000ER CRD5501-4000ER	Charges up to four MC67 devices and connects the MC67 with an Ethernet network. CRD5500-4000ER provides up to a maximum of 100 Mbps. CRD5501-4000ER provides up to a maximum of 1 Gbps.
Vehicle Cradle	VCD5500-1001R	Installs in a vehicle and charges the MC67 main battery.
Vehicle Holder	VCH5500-1000R	Provides an alternative mounting solution for the MC67 in a vehicle. Requires the Auto Charge cable for charging the MC67 battery.
Chargers		
Four Slot Spare Battery Charger	SAC5500-4000CR	Charges up to four MC67 battery packs.

Table 10-1 MC67 Accessories (Continued)

Accessory	Part Number	Description
Power Supply	PWRS-14000-249R	Provides power to the MC67 using the USB Charging Cable or Charge Only Cable.
Power Supply	PWRS-14000-148R	Provides power to the Single Slot USB cradle and Four Slot Spare Battery Charger.
Power Supply	PWRS-14000-241R	Provides power to the Four Slot Charge Only cradle or Four Slot Ethernet cradles.
USB Charging Cable	25-108022-03R	Provides power to the MC67 and USB communication with a host computer.
Charge Only Cable	25-112560-02R	Connects to a power supply to provide power to the MC67.
Auto Charge Cable	VCA5500-01R	Charges the MC67 using a vehicle's cigarette lighter.
DC Cable	50-16002-029R	Provides power from the power supply to the Four Slot cradles.
Miscellaneous		
Spare 3600 mAh lithium-ion battery	BTRY-MC55EAB02 BTRY-MC55EAB02-10 BTRY-MC55EAB02-50	Replacement 3600 mAh battery. (10-pack) (50-pack)
DEX Cable	25-127558-01R	For use with electronic data exchange For example, vending machines.
USB Client Communication Cable	25-68596-01R	Provides USB communication between the Single Slot USB Cradle and a host computer.
Printer Cable	25-136283-01R	Provides connection to a Monarch/Paxar Serial printer.
Trigger Handle	TRG5500-101R	Adds a gun-style handle with a scanning trigger for comfortable and productive data capture.
Trigger Handle Hand Strap	21-138874-01R	Handstrap for the Trigger handle.
Magnetic Stripe Reader	MSR5500-100R	Captures data from magnetic stripe cards.
Belt Mounted Rigid Holster	SG-MC5511110-01R	Clips onto belt to hold the MC67 when not in use.
Fabric Holster	SG-MC5521110-01R	Soft holder for added protection.
Stylus	KT-119150-03R KT-119150-50R	Replacement stylus (3-pack). Replacement stylus (50-pack).
Spring Loaded Stylus	STYLUS-00001-03R STYLUS-00001-10R	Optional spring loaded stylus (3-pack). Optional spring loaded stylus (10-pack).
Stylus with Tether	Stylus-00003-03R Stylus-00003-50R	Spare stylus with tether (3-pack). (50-pack).
Spare Tether	KT-122621-03R KT-122621-50R	Replacement tether (3-pack). (50-pack).
Handstrap	SG-MC5523341-03R	Replacement handstrap with pin
Wall Mounting Kit	KT-136648-01R	Use for wall mounting the four slot cradles.
Screen Protector	KT-137521-03R	Package of 3 screen protectors.

Single Slot USB Cradle

This section describes how to use a Single Slot USB cradle with the MC67. For USB communication setup procedures refer to the *MC67 Integrator Guide*.

The Single Slot USB Cradle:

- Provides 5.4 VDC power for operating the MC67.
- Synchronizes information between the MC67 and a host computer. Refer to the *MC67 Integrator Guide* for information on setting up a partnership between the MC67 and a host computer.
- Charges the MC67's battery.
- Charges a spare battery.

Charging the MC67 Battery

Connect the cradle to power. Insert the MC67 into the slot to begin charging.

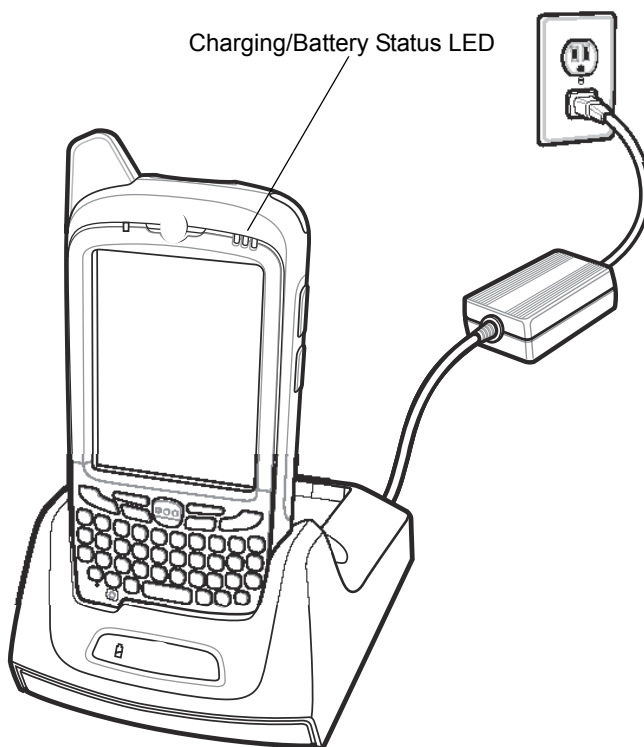

Figure 10-1 MC67 Battery Charging

Charging the Spare Battery

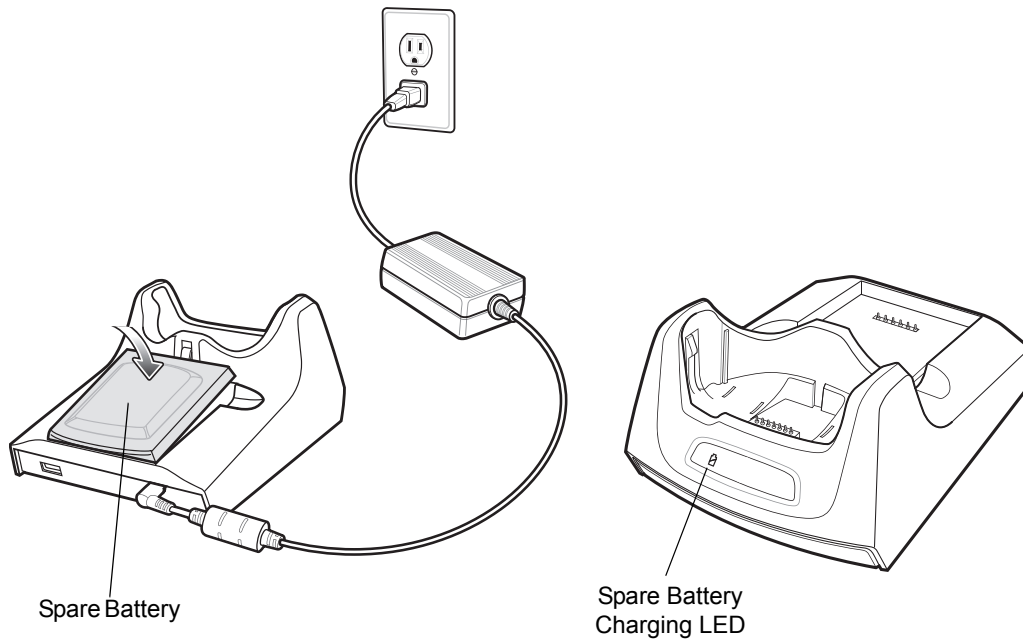

Figure 10-2 Spare Battery Charging

Battery Charging Indicators

The Single Slot USB Cradle charges the MC67's main battery and a spare battery simultaneously.

The MC67's charge LED indicates the status of the battery charging in the MC67. See [Table 1-1 on page 1-6](#) for charging status indications.

The spare battery charging LED on the cradle indicates the status of the spare battery charging in the cradle. See [Table 10-2](#) for charging status indications.

The 3600 mAh battery fully charges in less than six hours.

Charging Temperature

Charge batteries in temperatures from 0°C to 40°C (32°F to 104°F). Charging is intelligently controlled by the MC67.

To accomplish this, for small periods of time, the MC67 or accessory alternately enables and disables battery charging to keep the battery at acceptable temperatures. The MC67 or accessory indicates when charging is disabled due to abnormal temperatures via its LED. See [Table 1-1 on page 1-6](#) and [Table 10-2](#).

Table 10-2 Spare Battery LED Charging Indicators

Spare Battery LED (on cradle)	Indication
Off	Battery is not charging; battery is not inserted correctly in the cradle; cradle is not powered
Slow Blinking Amber	Spare battery is charging.
Solid Amber	Charging complete.
Fast Blinking Amber	Charging error.

Single-slot Ethernet/Modem/USB Cradle

The CRD5500-1000XR cradle provides connection to a host computer using USB, a dial-up network using the modem or an Ethernet network.

Refer to the *MC67 Integrator Guide* for information on setting up the cradle.

Country Settings

The modem defaults to operation with US telephone networks. To operate the modem with other country telephone networks, it must be configured using an application on the MC67. Download the *Cradle Modem Country Configurator Application Software for MC55xx* package from the Zebra Support Central web site: <http://www.zebra.com/support>.

Following the instructions with the software package to install the application on the MC67.

The application includes country selections for all supported countries and automatically programs the modem and adjust its operating parameters to comply with the telephone network in the selected country.

Connection Setup

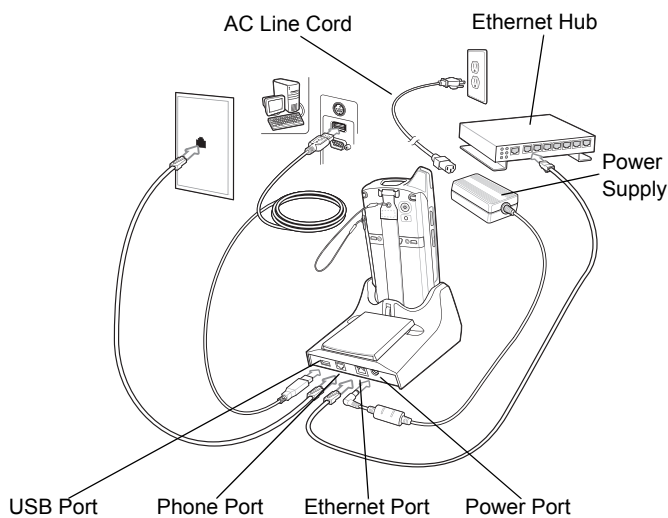

Figure 10-3 Connection Setup

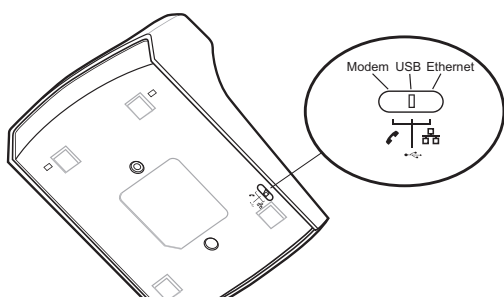

Figure 10-4 Connection Switch

Indicators

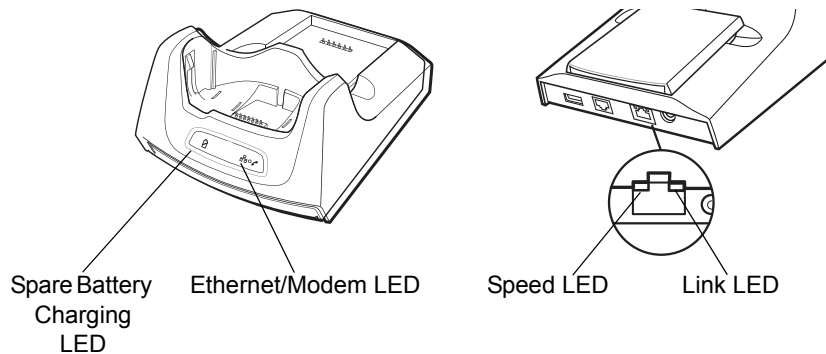

Figure 10-5 Indicators

- **Spare Battery Charging LED** - Indicates the charging status of the spare battery.
- **Ethernet/Modem LED** - Blink whenever Ethernet or modem connectivity is established.
- **Speed LED (green)** - Indicates that the transfer rate is 100 Mbps. When it is not lit it indicates that the transfer rate is 10 Mbps.
- **Link LED (yellow)** - Blinks to indicate activity, or stays lit to indicate that a link is established. When it is not lit it indicates there is no link.

Operation



NOTE The CRD5500-1000XR does not support hot swapping between operational modes. After moving the switch into a different position, remove the MC67 from the cradle and then re-insert into the cradle.

Ethernet Connection

Place the Connection switch on the bottom of the cradle to the Ethernet position.

Place the MC67 into the cradle.

To test the connection, tap  > **Programs** > **Internet Explorer**. Enter a web address.

Modem Connection

Place the Connection switch on the bottom of the cradle to the Modem position.

Place the MC67 into the cradle.

The MC67 dials the phone number and connects to the web site.

Four Slot Charge Only Cradle

This section describes how to set up and use a Four Slot Charge Only cradle with the MC67.

The Four Slot Charge Only cradle:

- Provides 5.4 VDC power for operating the MC67.
- Simultaneously charges up to four MC67 devices.

Charging

Insert the MC67 into a slot to begin charging.

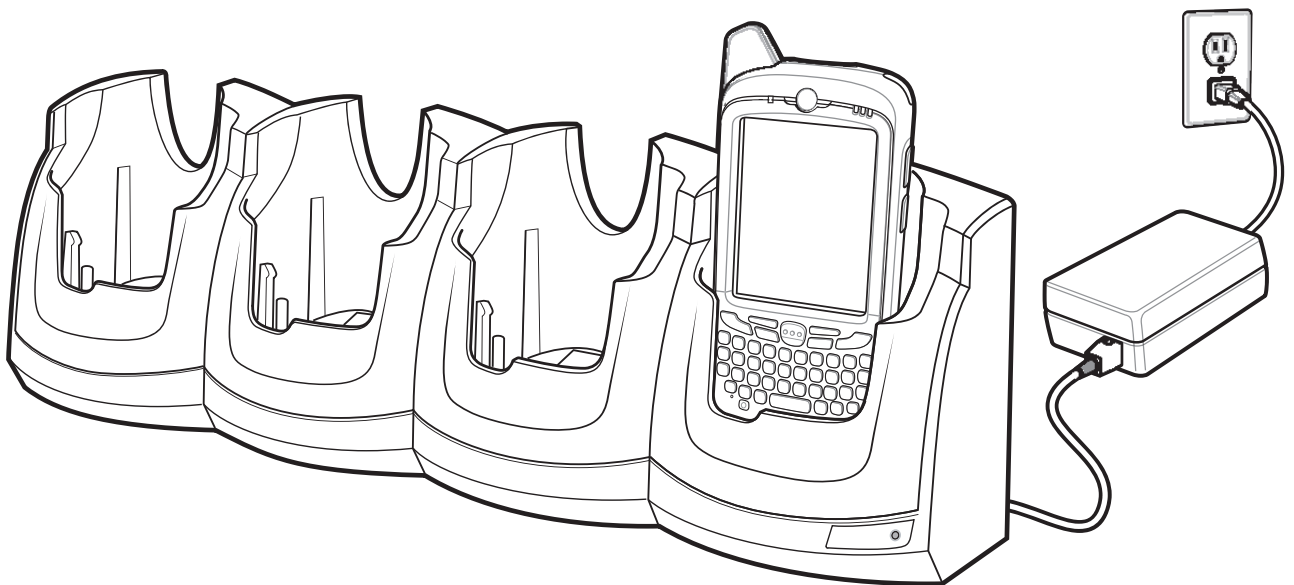

Figure 10-6 MC67 Battery Charging

Battery Charging Indicators

The MC67's charge LED shows the status of the battery charging in the MC67. See [Table 1-1 on page 1-6](#) for charging status indications.

The 3600 mAh battery fully charges in less than six hours.

Charging Temperature

Charge batteries in temperatures from 0°C to 40°C (32°F to 104°F). Charging is intelligently controlled by the MC67.

To accomplish this, for small periods of time, the MC67 or accessory alternately enables and disables battery charging to keep the battery at acceptable temperatures. The MC67 or accessory indicates when charging is disabled due to abnormal temperatures via its LED. See [Table 1-1 on page 1-6](#).

Four Slot Ethernet Cradle

This section describes how to use a Four Slot Ethernet cradle with the MC67. For cradle communication setup procedures refer to the *MC67 Integrator Guide*.

The Four Slot Ethernet cradle:

- Provides 5.4 VDC power for operating the MC67.
- Connects the MC67 (up to four) to an Ethernet network.
- Simultaneously charges up to four MC67 devices.

Charging

Insert the MC67 into a slot to begin charging.

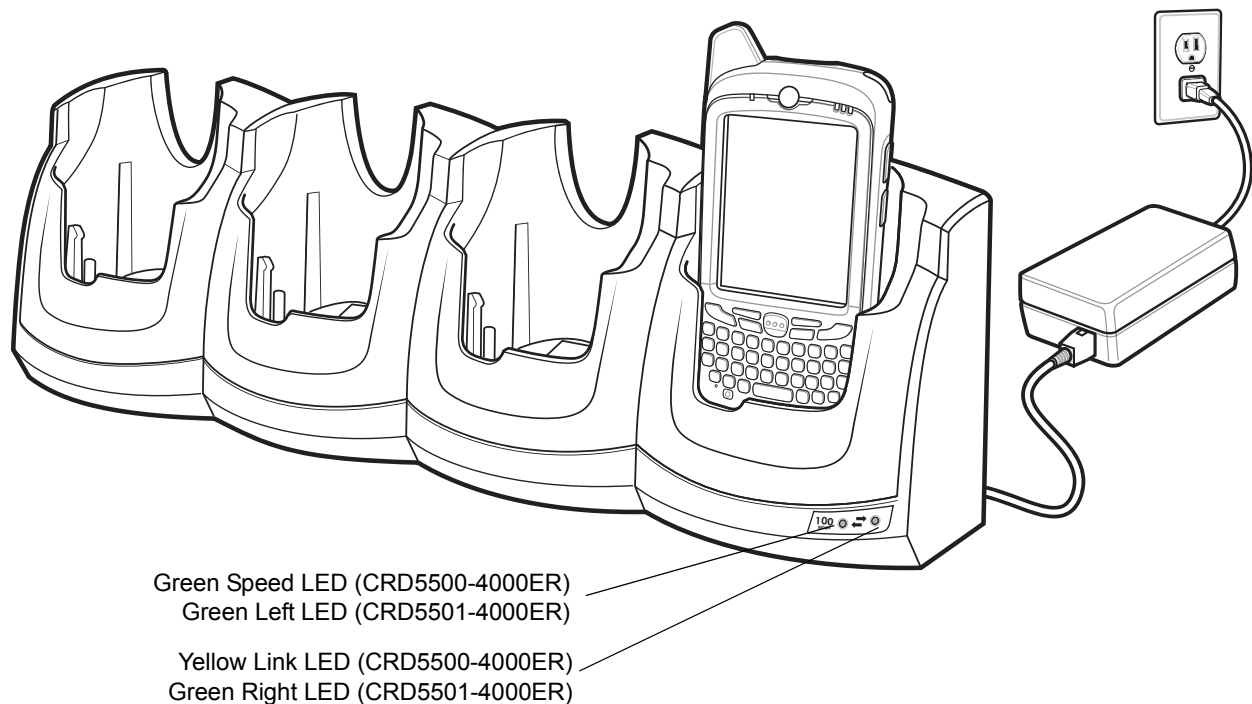

Figure 10-7 MC67 Battery Charging

The MC67's charge LED shows the status of the battery charging in the MC67. See [Table 1-1 on page 1-6](#) for charging status indications. The 3600 mAh battery fully charges in less than six hours.

Charge batteries in temperatures from 0°C to 40°C (32°F to 104°F). Charging is intelligently controlled by the MC67.

To accomplish this, for small periods of time, the MC67 alternately enables and disables battery charging to keep the battery at acceptable temperatures. The MC67 indicates when charging is disabled due to abnormal temperatures via its LED. See [Table 1-1 on page 1-6](#).

Communication

Insert the MC67 into the slot to initiate communication over an Ethernet network. The LEDs on the front of the cradle indicate the speed and activity of the connection.

LED Indicators (CRD5500-4000ER)

There are two LEDs on the front of the cradle. The green Speed LED lights to indicate that the transfer rate is 100 Mbps. When the LED is not lit the transfer rate is 10 Mbps. The yellow Link LED blinks to indicate activity, or stays lit to indicate that a link is established. When it is not lit it indicates that there is no link.

Table 10-3 CRD5500-4000ER LED Data Rate Indicators

Data Rate	Green Speed LED (Left)	Yellow Link LED (Right)
100 Mbps	On	On/Blink
10 Mbps	Off	On/Blink

LED Indicators (CRD5501-4000ER)

There are two green LEDs on the front of the cradle. These green LEDs light and blink to indicate the data transfer rate. When the LEDs are not lit the transfer rate is 10 Mbps.

Table 10-4 CRD5501-4000ER LED Data Rate Indicators

Data Rate	Left LED (Green)	Right LED (Green)
1 Gbps	On/Blink	Off
100 Mbps	Off	On/Blink
10 Mbps	Off	Off

Magnetic Stripe Reader

The MSR snaps on to the bottom of the MC67 and removes easily when not in use. When attached to the MC67, the MSR allows the MC67 to capture data from magnetic stripe cards. With the MSR attach, the MC67 can still be charged by placing the MC67 with MSR into a cradle or connecting to a charging cable.

Attaching and Removing the MSR

To attach, slide the MSR onto the bottom of the MC67 and secure by snapping the arms into the MC67 housing.

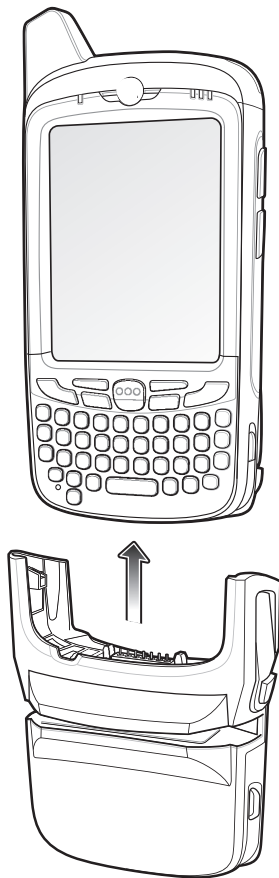

Figure 10-8 MSR Installation

To remove the MSR open the arms and pull the MSR from the MC67.



NOTE When attaching a cable with a cup connector through the MSR to charge the device, you cannot swipe cards.

Using the MSR

Install an MSR enabled application onto the MC67.

To use the MSR:

1. Attach the MSR to the MC67.

2. Power on the MC67.
3. Launch the MSR application.
4. Swipe the magnetic stripe card through the MSR, with the magnetic stripe on the card facing down. Swipe the card in either direction, from left to right or from right to left. For best results, gently press down on the card while swiping to ensure contact with the bottom of the reader.
5. The application indicates if the data has been read correctly.

VCD5000 Vehicle Cradle

This section describes how to use a VCD5000 vehicle cradle with the MC67. For cradle installation and communication setup procedures refer to the *MC67 Integrator Guide*.

Once installed in a vehicle, the cradle:

- holds the MC67 securely in place
- provides power for operating the MC67
- re-charges the battery in the MC67.

Charging the MC67 Battery

Insert the MC67 into the vehicle cradle to begin charging. A click indicates that the MC67 button release locking mechanism is enabled and the MC67 is locked in place.

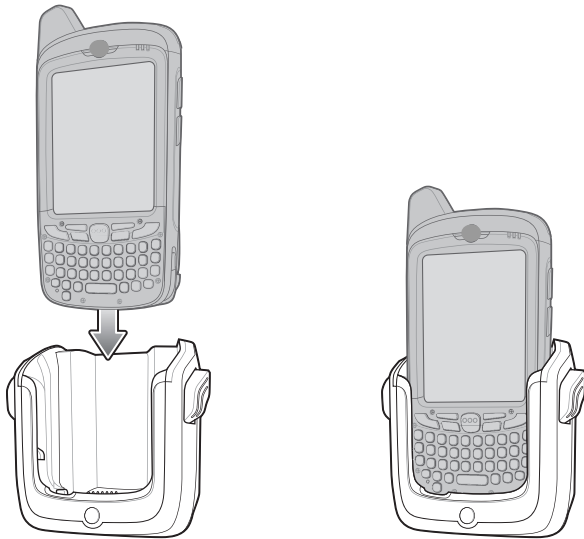

Figure 10-9 MC67 Battery Charging



CAUTION Ensure the MC67 is fully inserted in the cradle. Lack of proper insertion may result in property damage or personal injury. Zebra is not responsible for any loss resulting from the use of the products while driving.

Removing the MC67

To remove the MC67, hold back the release lever on the cradle and pull the MC67 up and out of the cradle.

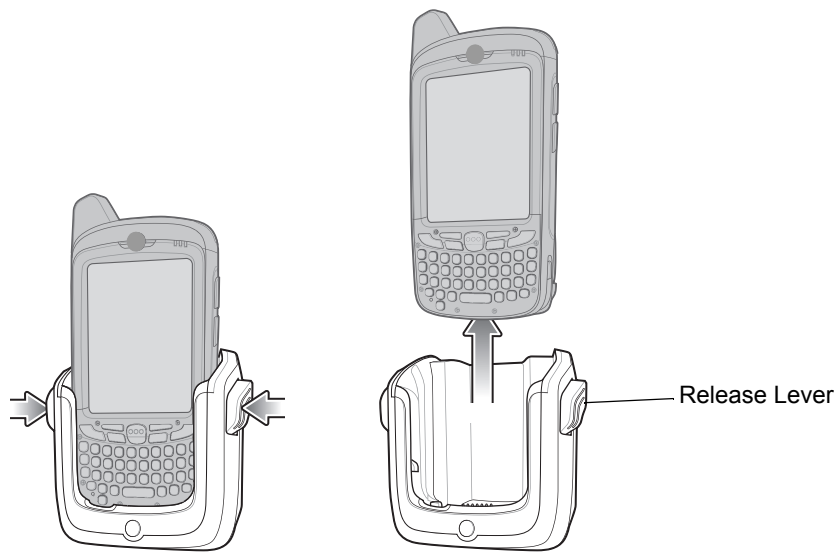

Figure 10-10 *Removing the MC67*

Battery Charging Indicators

The MC67's charge LED indicates the status of the battery charging in the MC67. See [Table 1-1 on page 1-6](#) for charging status indications.

The 3600 mAh battery fully charges in less than six hours.

Charging Temperature

Charge batteries in temperatures from 0°C to 40°C (32°F to 104°F). Charging is intelligently controlled by the MC67.

To accomplish this, for small periods of time, the MC67 alternately enables and disables battery charging to keep the battery at acceptable temperatures. The MC67 indicates when charging is disabled due to abnormal temperatures via its LED. See [Table 1-1 on page 1-6](#).

Four Slot Battery Charger

This section describes how to use the Four Slot Battery Charger to charge up to four MC67 batteries.

Battery Charging

1. Connect the charger to a power source.
2. Insert the battery into a battery charging well and gently press down on the battery to ensure proper contact.

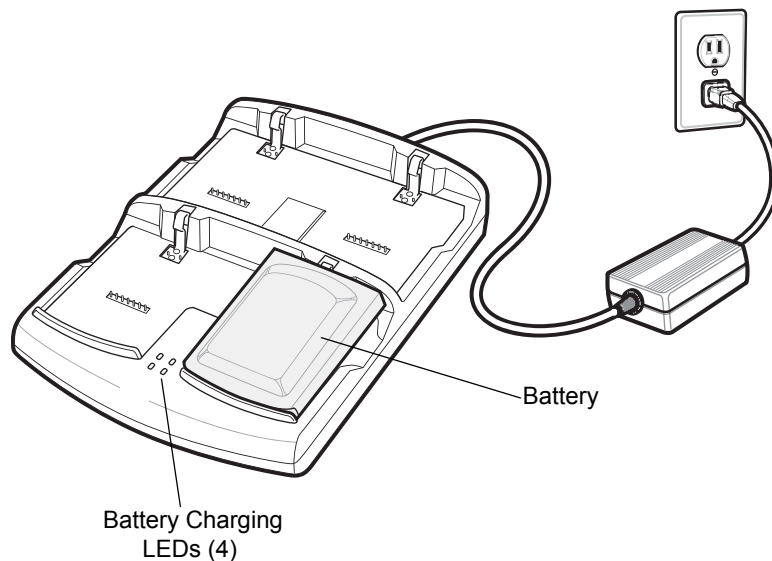

Figure 10-11 *Four Slot Battery Charger*

Battery Charging Indicators

The charger has an amber LED for each battery charging well. See [Table 10-5](#) for charging status indications. The 3600 mAh battery fully charges in less than six hours.

Charging Temperature

Charge batteries in temperatures from 0°C to 40°C (32°F to 104°F). Charging is intelligently controlled by the MC67.

To accomplish this, for small periods of time, the charger alternately enables and disables battery charging to keep the battery at acceptable temperatures. The charger indicates when charging is disabled due to abnormal temperatures via its LED. See [Table 10-5](#).

Table 10-5 *Battery LED Charging Indicators*

LED	Indication
Off	No battery in slot; battery is not charging; battery is not inserted correctly in the charger; charger is not powered.
Slow Blinking Amber	Battery is charging.
Solid Amber	Charging complete.
Fast Blinking Amber	Charging error.

Cables

This section describes how to set up and use the cables. The cables are available with a variety of connection capabilities.

The following communication/charge cables are available:

- USB Charging cable
 - Provide the MC67 with operating and charging power when used with the Zebra approved power supply.
 - Synchronize information between the MC67 and a host computer. With customized or third party software, it can also synchronize the MC67 with corporate databases.
- Charge Only cable
 - Provide the MC67 with operating and charging power when used with the Zebra approved power supply.
- Auto Charge cable.
 - Provide the MC67 with operating and charging power when used with the Zebra approved power supply.
- DEX cable
 - Provides communication with electronic data exchange devices, such as vending machines.

Battery Charging and Operating Power

The communication/charge cables can charge the MC67 battery and supply operating power.

To charge the MC67 battery:

1. Connect the communication/charge cable power input connector to the Zebra approved power source.
2. Slide the bottom of the MC67 into the connector cup end of the communication/charge cable and gently press in until it latches into the MC67.
3. Slide the two locking tabs up until they both lock into position.

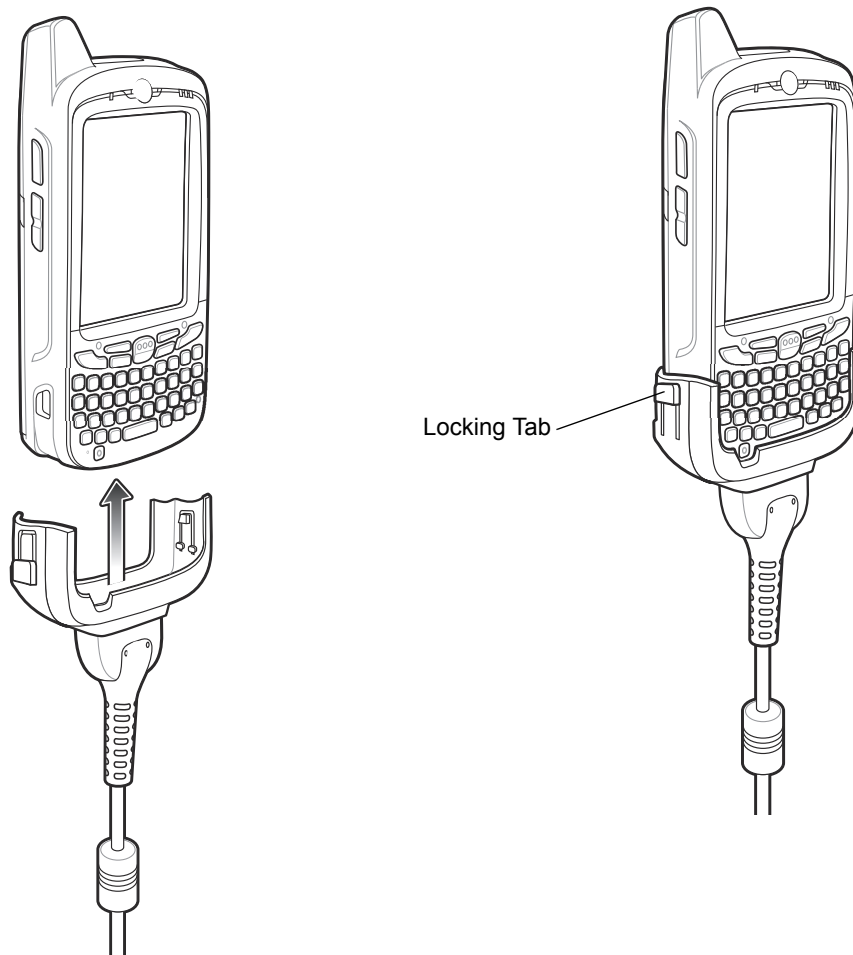

Figure 10-12 Cable Cup Locking Tabs

The MC67 amber Charge LED indicates the MC67 battery charging status. The 3600 mAh standard battery charges in less than six hours. See [Table 1-1 on page 1-6](#) for charging status indications.

4. When charging is complete, push the two locking tab down and remove the cable from the MC67.

LED Charge Indications

The amber Charge LED on the MC67 indicates battery charging status. See [Table 1-1 on page 1-6](#) for charging status indications.

Charging Temperature

Charge batteries in temperatures from 0°C to 40°C (32°F to 104°F). Charging is intelligently controlled by the MC67.

To accomplish this, for small periods of time, the MC67 or accessory alternately enables and disables battery charging to keep the battery at acceptable temperatures. The MC67 or accessory indicates when charging is disabled due to abnormal temperatures via its LED. See [Table 1-1 on page 1-6](#).

Trigger Handle

The TRG5500 Trigger Handle adds a gun-style handle with a scanning trigger to the MC67. It increases comfort when using the MC67 in scan-intensive applications for extended periods of time.

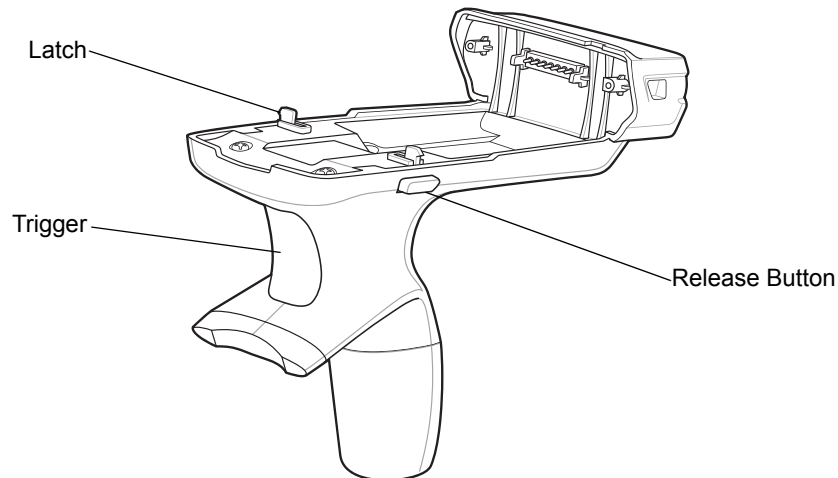

Figure 10-13 Trigger Handle Features

Inserting the MC67 into the Trigger Handle

Slide the MC67 into the Trigger Handle until it locks in place. The latches secure the MC67 to the Trigger Handle.

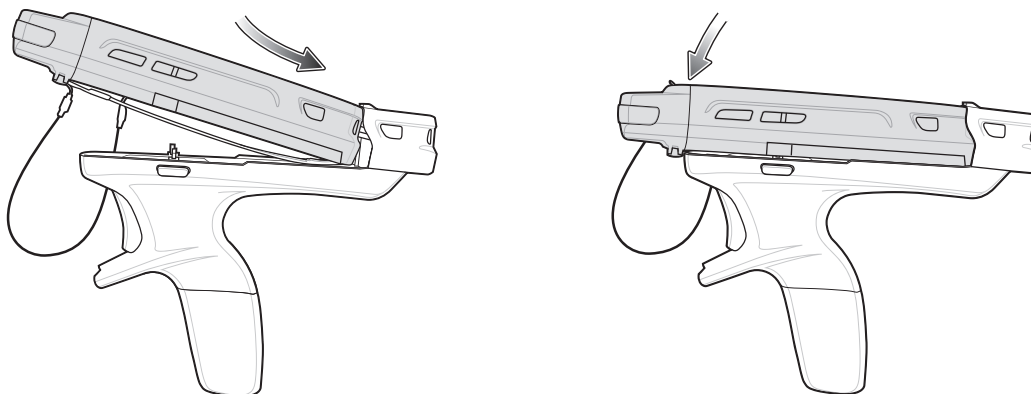

Figure 10-14 Installing the MC67

Removing the MC67

To remove the MC67, press the release buttons and pull the MC67 forward.

Scanning

To scan bar codes:

✓ **NOTE** A scanning application must be installed prior to scanning a bar code.

1. Start the MC67's scanning application.
2. Aim the MC67 at the bar code.
3. Press the trigger on the handle. The Scan/Decode LED lights and a beep sounds to indicate a successful decode.

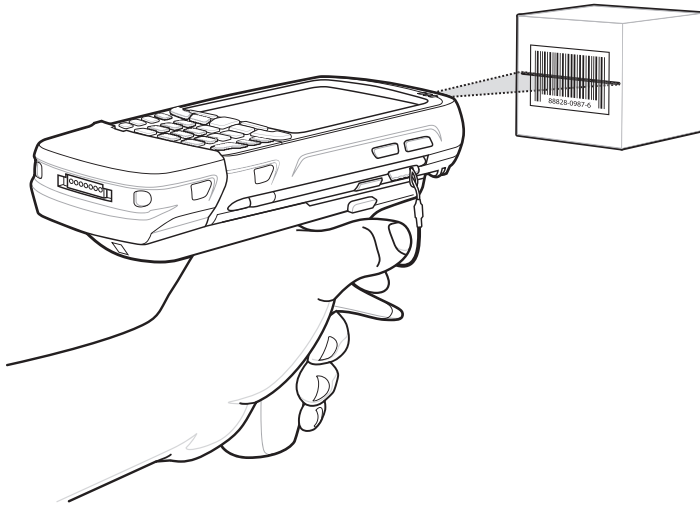



Figure 10-15 *Scanning with the Trigger Handle*

Using the RS507 Hands-free Imager

An RS507 Hands-free Imager can be used with the MC67 to capture bar code data.

To set up the MC67 and RS507:

1. Tap  > **BTScannerCtlPanel** icon.
2. Select the **BT Scanner** checkbox and then select the appropriate Com port from the drop-down list.
3. Tap **Save and Exit**.
4. Tap  > **MotoBTUI**.
5. Tap **Pairing Barcode**. A bar code displays.

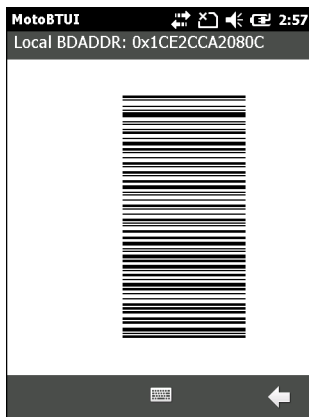

Figure 10-16 *Pairing Bar Code*

6. Point the RS507 at the bar code. The RS507 reads the bar code and begins pairing with the MC67. If required, enter PIN (12345). Tap **Yes**.
7. If using DataWedge, configure DataWedge to use the Bluetooth SSI Scanner Driver. See [DataWedge on page 3-5](#) for setup instructions.
8. Launch a scanning enabled application or DataWedge.
9. Point the RS507 at a bar code to read the bar code data.

Refer to the *RS507 Hands-free Imager Product Reference Guide* for more information.

CHAPTER 11 MAINTENANCE & TROUBLESHOOTING

Introduction

This chapter includes instructions on cleaning and storing the MC67, and provides troubleshooting solutions for potential problems during MC67 operation.

Maintaining the MC67

For trouble-free service, observe the following tips when using the MC67:

- Do not scratch the screen of the MC67. When working with the MC67, use the supplied stylus or plastic-tipped pens intended for use with a touch-sensitive screen. Never use an actual pen or pencil or other sharp object on the surface of the MC67 screen.

Zebra recommends using a screen protector, p/n KT-129195-01R.

- The touch-sensitive screen of the MC67 is glass. Do not drop the MC67 or subject it to strong impact.
- Protect the MC67 from temperature extremes. Do not leave it on the dashboard of a car on a hot day, and keep it away from heat sources.
- Do not store or use the MC67 in any location that is dusty, damp, or wet.
- Use a soft lens cloth to clean the MC67. If the surface of the MC67 screen becomes soiled, clean it with a soft cloth moistened with a diluted window-cleaning solution.
- Periodically replace the rechargeable battery to ensure maximum battery life and product performance. Battery life depends on individual usage patterns.

- A screen protector is applied to the MC67. Zebra recommends using this to minimize wear and tear. Screen protectors enhance the usability and durability of touch screen displays. Benefits include:
 - Protection from scratches and gouges
 - Durable writing and touch surface with tactile feel
 - Abrasion and chemical resistance
 - Glare reduction
 - Keeping the device's screen looking new
 - Quick and easy installation.

Removing the Screen Protector

A screen protector is applied to the MC67. Zebra recommends using this to minimize wear and tear. Screen protectors enhance the usability and durability of touch screen displays.

To remove the screen protector, lift the corner using a thin plastic card, such as a credit card, then carefully lift it off the display.

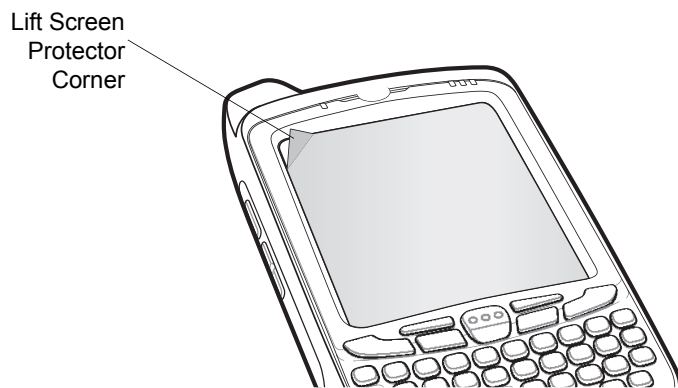

Figure 11-1 *Removing the Screen Protector*



CAUTION Do not use a sharp object to remove the protector. Doing so can damage the touch panel.



NOTE Not using a screen protector can affect warranty coverage. To purchase replacement protectors, contact a local account manager or Zebra Technologies Corporation. These include screen protector installation instructions. Part number: KT-129195-01R Screen Protector 3/pk.

Battery Safety Guidelines

- The area in which the units are charged should be clear of debris and combustible materials or chemicals. Particular care should be taken where the device is charged in a non commercial environment.
- Follow battery usage, storage, and charging guidelines found in the user's guide.
- Improper battery use may result in a fire, explosion, or other hazard.

- To charge the mobile device battery, the battery and charger temperatures must be between +32 °F and +104 °F (0 °C and +40 °C)
- Do not use incompatible batteries and chargers. Use of an incompatible battery or charger may present a risk of fire, explosion, leakage, or other hazard. If the user has any questions about the compatibility of a battery or a charger, contact Zebra Global Customer Support.
- For devices that utilize a USB port as a charging source, the device shall only be connected to products that bear the USB-IF logo or have completed the USB-IF compliance program.
- To enable authentication of an approved battery, as required by IEEE1725 clause 10.2.1, all batteries will carry a Zebra hologram. Do not fit any battery without checking it has the Zebra authentication hologram.
- Do not disassemble or open, crush, bend or deform, puncture, or shred.
- Severe impact from dropping any battery-operated device on a hard surface could cause the battery to overheat.
- Do not short circuit a battery or allow metallic or conductive objects to contact the battery terminals.
- Do not modify or remanufacture, attempt to insert foreign objects into the battery, immerse or expose to water or other liquids, or expose to fire, explosion, or other hazard.
- Do not leave or store the equipment in or near areas that might get very hot, such as in a parked vehicle or near a radiator or other heat source. Do not place battery into a microwave oven or dryer.
- Battery usage by children should be supervised.
- Please follow local regulations to properly dispose of used re-chargeable batteries.
- Do not dispose of batteries in fire.
- In the event of a battery leak, do not allow the liquid to come in contact with the skin or eyes. If contact has been made, wash the affected area with large amounts of water and seek medical advice.
- If the user suspects damage to the equipment or battery, contact Zebra Global Customer Support to arrange for inspection.

Cleaning



CAUTION Always wear eye protection.

Read warning label on compressed air and alcohol product before using.

If the user has to use any other solution for medical reasons please contact Zebra for more information.



WARNING! Avoid exposing this product to contact with hot oil or other flammable liquids. If such exposure occurs, unplug the device and clean the product immediately in accordance with these guidelines.

Approved Cleanser Active Ingredients

100% of the active ingredients in any cleaner must consist of one or some combination of the following: isopropyl alcohol, bleach/sodium hypochlorite, hydrogen peroxide or mild dish soap.

Harmful Ingredients

The following chemicals are known to damage the plastics on the MC67 and should not come in contact with the device: ammonia solutions, compounds of amines or ammonia; acetone; ketones; ethers; aromatic and chlorinated hydrocarbons; aqueous or alcoholic alkaline solutions; ethanalamine; toluene; trichloroethylene; benzene; carbolic acid and TB-lysoform.

Cleaning Instructions

Do not apply liquid directly to the MC67. Dampen a soft cloth or use pre-moistened wipes. Do not wrap the device in the cloth or wipe, but gently wipe the unit. Be careful not to let liquid pool around the display window or other places. Allow the unit to air dry before use.

Special Cleaning Notes

Many vinyl gloves contain phthalate additives, which are often not recommended for medical use and are known to be harmful to the housing of the MC67. The MC67 should not be handled while wearing vinyl gloves containing phthalates, or before hands are washed to remove contaminant residue after gloves are removed. If products containing any of the harmful ingredients listed above are used prior to handling the MC67, such as hand sanitizer that contain ethanalamine, hands must be completely dry before handling the MC67 to prevent damage to the plastics.

Materials Required

- Alcohol wipes
- Lens tissue
- Cotton tipped applicators
- Isopropyl alcohol
- Can of compressed air with a tube.

Cleaning the MC67

Housing

Using the alcohol wipes, wipe the housing including keys and in-between keys.

Display

The display can be wiped down with the alcohol wipes, but care should be taken not to allow any pooling of liquid around the edges of the display. Immediately dry the display with a soft, non-abrasive cloth to prevent streaking.

Scanner Exit Window

Wipe the scanner exit window periodically with a lens tissue or other material suitable for cleaning optical material such as eyeglasses.

Connector

1. Remove the main battery from mobile computer. See [Replacing the Battery on page 1-7](#).
2. Dip the cotton portion of the cotton tipped applicator in isopropyl alcohol.

3. Rub the cotton portion of the cotton tipped applicator back-and-forth across the connector on the bottom of the MC67. Do not leave any cotton residue on the connector.
4. Repeat at least three times.
5. Use the cotton tipped applicator dipped in alcohol to remove any grease and dirt near the connector area.
6. Use a dry cotton tipped applicator and repeat steps 4 through 6.
7. Spray compressed air on the connector area by pointing the tube/nozzle about ½ inch away from the surface.



CAUTION Do not point nozzle at yourself and others, ensure the nozzle or tube is away from your face.

8. Inspect the area for any grease or dirt, repeat if required.

Cleaning Cradle Connectors

To clean the connectors on a cradle:

1. Remove the DC power cable from the cradle.
2. Dip the cotton portion of the cotton tipped applicator in isopropyl alcohol.
3. Rub the cotton portion of the cotton tipped applicator along the pins of the connector. Slowly move the applicator back-and-forth from one side of the connector to the other. Do not let any cotton residue on the connector.
4. All sides of the connector should also be rubbed with the cotton tipped applicator.
5. Spray compressed air in the connector area by pointing the tube/nozzle about ½ inch away from the surface.



CAUTION Do not point nozzle at yourself and others, ensure the nozzle or tube is away from your face.

6. Ensure that there is no lint left by the cotton tipped applicator, remove lint if found.
7. If grease and other dirt can be found on other areas of the cradle, use lint free cloth and alcohol to remove.
8. Allow at least 10 to 30 minutes (depending on ambient temperature and humidity) for the alcohol to air dry before applying power to cradle.

If the temperature is low and humidity is high, longer drying time is required. Warm temperature and dry humidity requires less drying time.

Cleaning Frequency

The cleaning frequency is up to the customer's discretion due to the varied environments in which the mobile devices are used. They may be cleaned as frequently as required. However when used in dirty environments it may be advisable to periodically clean the scanner exit window to ensure optimum scanning performance.

Troubleshooting

MC67

Table 11-1 *Troubleshooting the MC67*

Problem	Cause	Solution
When pressing the power button the MC67 does not turn on.	Battery not charged.	Charge or replace the battery in the MC67.
	Battery not installed properly.	Install the battery properly. See Installing the Battery on page 1-4 .
	System crash.	Perform a reset. See Resetting the MC67 on page 2-12 .
When pressing the power button the MC67 does not turn on but two LEDs blink.	Battery charge is at a level where data is maintained but battery should be re-charged.	Charge or replace the battery in the MC67.
Battery did not charge.	Battery failed.	Replace battery. If the MC67 still does not operate, perform a reset. See Resetting the MC67 on page 2-12 .
	MC67 removed from cradle while battery was charging.	Insert MC67 in cradle. The 3600 mAh battery fully charges in less than six hours.
	Extreme battery temperature.	Battery does not charge if ambient temperature is below 0°C (32°F) or above 40°C (104°F).
Cannot see characters on display.	MC67 not powered on.	Press the Power button.
During data communication, no data transmitted, or transmitted data was incomplete.	MC67 removed from cradle or disconnected from host computer during communication.	Replace the MC67 in the cradle, or reattach the communication cable and re-transmit.
	Incorrect cable configuration.	See the system administrator.
	Communication software was incorrectly installed or configured.	Perform setup. Refer to the <i>MC67 Integrator Guide</i> for details.
No sound.	Volume setting is low or turned off.	Adjust the volume. See Adjusting Volume on page 2-12 .

Table 11-1 Troubleshooting the MC67 (Continued)



Problem	Cause	Solution
MC67 shuts off.	MC67 is inactive.	The MC67 turns off after a period of inactivity. If the MC67 is running on battery power, set this period from 1 to 5 minutes, in one-minute intervals. Tap  > Settings > System > Power > Advanced to configure.
	Battery is depleted.	Replace the battery.
	Battery is not inserted properly.	Insert the battery properly. See Installing the Battery on page 1-4 .
Tapping the window buttons or icons does not activate the corresponding feature.	Screen is not calibrated correctly.	Re-calibrate the screen. See Calibrating the Screen on page 1-7 .
	The device is not responding.	Reset the device. See Resetting the MC67 on page 2-12 .
A message appears stating that the MC67 memory is full.	Too many files stored on the MC67.	Delete unused memos and records. If necessary, save these records on the host computer (or use an SD card for additional memory).
	Too many applications installed on the MC67.	Remove user-installed applications on the MC67 to recover memory. Tap  > Settings > System tab and tap the Remove Programs icon. Select the unused program and tap Remove .

Table 11-1 *Troubleshooting the MC67 (Continued)*

Problem	Cause	Solution
The MC67 does not decode with reading bar code.	Scanning application is not loaded.	Load a scanning application on the MC67 or enable DataWedge. See DataWedge on page 3-5 or the system administrator.
	Unreadable bar code.	Ensure the symbol is not defaced.
	Distance between exit window and bar code is incorrect.	Place the MC67 within proper scanning range.
	MC67 is not programmed for the bar code.	Program the MC67 to accept the type of bar code being scanned. Refer to the EMDK or DataWedge application.
	MC67 is not programmed to generate a beep.	If the MC67 does not beep on a good decode, set the application to generate a beep on good decode.
	Battery is low.	If the scanner stops emitting a laser beam upon a trigger press, check the battery level. When the battery is low, the scanner shuts off before the MC67 low battery condition notification. Note: If the scanner is still not reading symbols, contact the distributor or Zebra.
	User is trying to decode a DPM bar code.	An MC67 with a DPM imager is required. Contact system administrator.
Error message "SIM Error. Cannot save information to the SIM" appears when copying contacts to a SIM card.	Feature not supported on some SIM cards.	If error appears while copying one contact, reboot the MC67. The contact appears on the SIM card after rebooting.
		If error appears while copying multiple contacts, copy one contact at a time and follow above solution.
		Use Microsoft Outlook Exchange and ActiveSync to synchronize contacts with Microsoft Outlook on host computer.
MC67 cannot find any Bluetooth devices nearby.	Too far from other Bluetooth devices.	Move closer to the other Bluetooth device(s), within a range of 10 meters (32.8 feet).
	The Bluetooth device(s) nearby are not turned on.	Turn on the Bluetooth device(s) to find.
	The Bluetooth device(s) are not in discoverable mode.	Set the Bluetooth device(s) to discoverable mode. If needed, refer to the device's user documentation for help.
Cannot unlock MC67.	User enters incorrect password.	If the user enters an incorrect password eight times, the user is requested to enter a code before trying again. If the user forgot the password, contact system administrator.

Single Slot USB Cradle

Table 11-2 Troubleshooting the Single Slot USB Cradle

Symptom	Possible Cause	Action
LEDs do not light when MC67 or spare battery is inserted.	Cradle is not receiving power.	Ensure the power cable is connected securely to both the cradle and to AC power.
	MC67 is not seated firmly in the cradle.	Remove and re-insert the MC67 into the cradle, ensuring it is firmly seated.
	Spare battery is not seated firmly in the cradle.	Remove and re-insert the spare battery into the charging slot, ensuring it is firmly seated.
MC67 battery is not charging.	MC67 was removed from cradle or cradle was unplugged from AC power too soon.	Ensure cradle is receiving power. Ensure MC67 is seated correctly. Confirm the main battery is charging. Tap  > Settings > Power > Battery tab. The 3600 mAh battery fully charges in less than six hours.
	Battery is faulty.	Verify that other batteries charge properly. If so, replace the faulty battery.
	The MC67 is not fully seated in the cradle.	Remove and re-insert the MC67 into the cradle, ensuring it is firmly seated.
	Extreme battery temperature.	Battery does not charge if ambient temperature is below 0°C (32°F) or above 40°C (104°F).
Spare battery is not charging.	Battery not fully seated in charging slot.	Remove and re-insert the spare battery in the cradle, ensuring it is firmly seated.
	Battery inserted incorrectly.	Re-insert the battery so the charging contacts on the battery align with the contacts on the cradle.
	Battery is faulty.	Verify that other batteries charge properly. If so, replace the faulty battery.
During data communication, no data transmits, or transmitted data was incomplete.	MC67 removed from cradle during communications.	Replace MC67 in cradle and retransmit.
	Communication software is not installed or configured properly.	Perform setup as described in the <i>MC67 Integrator Guide</i> .

Four Slot Ethernet Cradle

Table 11-3 *Troubleshooting the Four Slot Ethernet Cradle*

Symptom	Cause	Solution
During communication, no data transmits, or transmitted data was incomplete.	MC67 removed from cradle during communications.	Replace MC67 in cradle and retransmit.
	MC67 has no active connection.	An icon is visible in the status bar if a connection is currently active.
Battery is not charging.	MC67 removed from the cradle too soon.	Replace the MC67 in the cradle. The 3600 mAh battery fully charges in less than six hours.
	Battery is faulty.	Verify that other batteries charge properly. If so, replace the faulty battery.
	MC67 is not inserted correctly in the cradle.	Remove the MC67 and reinsert it correctly.
	Ambient temperature of the cradle is too warm.	Move the cradle to an area where the ambient temperature is between 0°C (32°F) and 50°C (122°F).

Vehicle Cradle

Table 11-4 *Troubleshooting the Vehicle Cradle*

Symptom	Possible Cause	Action
MC67 battery charging LED does not light up.	Cradle is not receiving power.	Ensure the power input cable is securely connected to the cradle's power port.
MC67 battery is not recharging.	MC67 was removed from the cradle too soon.	Replace the MC67 in the cradle. The 3600 mAh battery fully charges in less than six hours.
	Battery is faulty.	Replace the battery.
	MC67 is not placed correctly in the cradle.	Remove the MC67 from the cradle, and re-insert correctly. If the battery still does not charge, contact customer support. The MC67 battery charging LED slowly blinks amber when the MC67 is correctly inserted and charging.
	Ambient temperature of the cradle is too warm.	Move to an area where the ambient temperature is between -20°C and 50°C (-4°F and 122°F).

Four Slot Battery Charger

Table 11-5 *Troubleshooting The Four Slot Battery Charger*

Symptom	Possible Cause	Action
Battery not charging.	Battery was removed from the charger or charger was unplugged from AC power too soon.	Re-insert the battery in the charger or re-connect the charger's power supply. The 3600 mAh battery fully charges in less than six hours.
	Battery is faulty.	Verify that other batteries charge properly. If so, replace the faulty battery.
	Battery contacts not connected to charger.	Verify that the battery is seated in the battery well correctly with the contacts facing down.

Cables

Table 11-6 *Troubleshooting the Cables*

Symptom	Possible Cause	Action
MC67 battery is not charging.	MC67 was disconnected from AC power too soon.	Connect the power cable correctly. Confirm main battery is charging. Tap  > Power > Settings > Battery tab. The 3600 mAh battery fully charges in less than six hours.
	Battery is faulty.	Verify that other batteries charge properly. If so, replace the faulty battery.
	The MC67 is not fully attached to power.	Detach and re-attach the power cable to the MC67, ensuring it is firmly connected.
During data communication, no data transmits, or transmitted data was incomplete.	Cable was disconnected from MC67 during communications.	Re-attach the cable and retransmit.
	Incorrect cable configuration.	See the system administrator.
	Communication software is not installed or configured properly.	Perform setup as described in the <i>MC67 Integrator Guide</i> .

Magnetic Stripe Reader

Table 11-7 *Troubleshooting the Magnetic Stripe Reader*

Symptom	Possible Cause	Action
MSR cannot read card.	MSR removed from MC67 during card swipe.	Reattach MSR to MC67 and reswipe the card.
	Faulty magnetic stripe on card.	Try another card. If condition still exist, contact the system administrator.
	Swipe speed is too fast or too slow.	Re-swipe card using a constant swipe speed.
	MSR application is not installed or configured properly.	Ensure the MSR application is installed on the MC67. Ensure the MSR application is configured correctly.
MC67 battery is not charging.	MC67 was removed from MSR or MSR was unplugged from AC power too soon.	Ensure MSR is receiving power. Ensure MC67 is attached correctly. Confirm main battery is charging. Tap  > Settings > System > Power > Battery tab. The 3600 mAh battery fully charges in less than six hours.
	Battery is faulty.	Verify that other batteries charge properly. If so, replace the faulty battery.
	The MC67 is not fully attached to the MSR.	Detach and re-attach the MSR to the MC67, ensuring it is firmly connected.
During data communication, no data transmits, or transmitted data was incomplete.	MC67 detached from MSR during communications.	Reattach MC67 to MSR and retransmit.
	Incorrect cable configuration.	See the system administrator.
	Communication software is not installed or configured properly.	Perform setup as described in the <i>MC67 Integrator Guide</i> .

APPENDIX A TECHNICAL SPECIFICATIONS

This appendix provides specifications for the MC67 and accessories.

MC67

Table A-1 MC67 Technical Specifications

Item	Description
Physical Characteristics	
Dimensions	Height: 16.2 cm (6.38 in.) Width: 7.7 cm (3.03 in.) Depth: 3.35 cm (1.32 in.)
Weight	385 g (13.5 oz.)
Display	Color 3.5" video graphics adapter (VGA) with backlight, 65K colors, 480 W x 640 L 650+ NITS.
Touch Panel	Glass analog resistive touch
Backlight	Light Emitting Diode (LED) backlight
Battery Pack	Rechargeable Lithium Ion 3.7V, 3600 mAh battery
Backup battery	Nickel–metal hydride (Ni-MH) battery (rechargeable) 15 mAh 2.8V (non-user accessible or replaceable)
Expansion Slot	micro Secure Digital (SD) slot (supports up to 32 GB).
Connection Interface	Universal Serial Bus (USB) 2.0 High Speed (host and client)
Notification	Audible tone plus multi-color LEDs
Keypad Options	MC67NA: numeric, QWERTY, AZERTY, QWERTZ, Direct Store Delivery (DSD) or Personal Information Manager (PIM) MC67ND: numeric, QWERTY, AZERTY, QWERTZ or DSD

Table A-1 MC67 Technical Specifications (Continued)

Item	Description
Audio	Dual microphone support with noise cancellation; vibrate alert; speaker; Bluetooth headset
Performance Characteristics	
CPU	Dual-core OMAP 4, 1 GHz
Operating System	Microsoft® Windows Embedded Handheld 6.5.3 Professional
Memory	512 MB Random Access Memory (RAM)/2 GB Flash
Output Power	USB - 5 VDC @ 300 mA max.
User Environment	
Operating Temperature	-20°C to 50°C (-4°F to 122°F)
Storage Temperature	-40°C to 70°C (-40°F to 158°F)
Charging Temperature	0° C to 40° C (32°F to 104°F)
Humidity	5 to 95% non-condensing
Drop Specification	Multiple 2.4 m (8 ft.) drops per MIL-STD 810G at room temperature. 1.8 m (6 ft.) across operating temperature per MIL-STD 810G.
Tumble	1,000 1.6 ft./0.5 meter tumbles at room temperature; per applicable IEC tumble specifications
Electrostatic Discharge (ESD)	+/-15kVdc air discharge, +/-8kVdc direct discharge, +/-8kVdc indirect discharge
Sealing	IP67 per IEC specification.
Vibration	4 g's PK Sine (5 Hz to 2 kHz); 0.04g ² /Hz Random (20 Hz to 2 kHz); 60 minute duration per axis, 3 axis
Thermal Shock	-40° C to 70° C (-40° F to 158° F) rapid transition
Zebra Interactive Sensor Technology (IST)	
Motion Sensor	3-axis accelerometer provides motion-sensing for dynamic screen orientation and power management.
Light Sensor	Ambient light sensor to auto adjust display backlight brightness.
Digital Compass	Navigation aid for users.
Wireless WAN Data and Voice Communications	
Radio	4G HSPA+

Table A-1 MC67 Technical Specifications (Continued)

Item	Description
Frequency Band	MC67NA: UMTS/HSDPA and HSUPA: 850, 900, 1900 and 2100 MHz GSM/EDGE: 850, 900, 1800 and 1900 MHz MC67ND: UMTS/HSDPA and HSUPA: 850, 900, 1900 and 2100 MHz GSM/EDGE: 850, 900, 1800 and 1900 MHz CDMA/EvDO Rev A: (800 and 1900 MHz)
Wireless LAN Data and Voice Communications	
Radio	IEEE® 802.11a/b/g/n
Data Rates Supported	1, 2, 5.5, 6, 9, 11, 12, 18, 24, 36, 48, and 54 Mbps
Operating Channels	Chan 36 - 165 (5180 - 5825 MHz) Chan 1 - 13 (2412 - 2472 MHz) Chan 14 (2484 MHz) Japan only Actual operating channels/frequencies depend on regulatory rules and certification agency
Security	WPA2 (Personal or Enterprise); 802.1x; EAP-TLS; TTLS (CHAP, MS-CHAP, MS-CHAPv2, PAP or MD5); PEAP (TLS, MSCHAPv2, EAP-GTC); LEAP, EAP-FAST (TLS, MS-CHAPv2, EAP-GTC)
Voice Communications	Voice-over-IP ready, Wi-Fi™-certified, IEEE 802.11a/b/g/n direct sequence wireless LAN, Wi-Fi Multimedia™ (WMM and WMM-PS) Zebra Voice Quality Manager (VQM)
Wireless PAN Data and Voice Communications	
Bluetooth	Class II, v2.1 with Enhanced Data Rate (EDR)
Global Positioning System	
GPS	Integrated stand-alone or Assisted-GPS (A-GPS).
Data Capture Specifications	
Options	2D SE4500-SR imager 2D SE4500-SR imager and 8 MP camera 2D SE4500-DL imager 2D SE4500-DL imager and 8 MP camera 2D SE4500-DPM imager and 8 MP camera
Data Types	1D and 2D bar codes, DPM, photographs, video, signatures and documents.
Voice and Audio	
VoWWAN; VoWLAN; PPTT, VoIP-ready; high-quality speakerphone; wireless (Bluetooth) headset support; PPTT headset support; headset/speakerphone modes	

Table A-1 MC67 Technical Specifications (Continued)

Item	Description
2D Imager Engine (SE4500-SR) Specifications	
Field of View	Horizontal - 39.6° Vertical - 25.7°
Optical Resolution	WVGA 752 H x 480 V pixels (gray scale)
Roll	360°
Pitch Angle	+/- 60° from normal
Skew Tolerance	+/- 60° from normal
Ambient Light	Indoor: 450 ft. candles (4845 lux) Outdoor: 9000 ft. candles (96,900 lux) Sunlight: 8000 ft. candles Fluorescent: 450 ft. candles
Focal Distance	From center of exit window: 19 cm (7.5 in.)
Aiming Element (VLD)	655 nm +/- 10 nm
Illumination Element (LED)	625 nm +/- 5 nm
2D Imager Engine (SE4500-DL) Specifications	
Field of View	Horizontal - 39.2° Vertical - 25.4°
Optical Resolution	WVGA 752 H x 480 V pixels (gray scale)
Roll	360°
Pitch Angle	+/- 60° from normal
Skew Tolerance	+/- 60° from normal
Ambient Light	Indoor: 450 ft. candles (4845 lux) Outdoor: 9000 ft. candles (96,900 lux) Sunlight: 8000 ft. candles Fluorescent: 450 ft. candles
Focal Distance	From center of exit window: 18.5 cm (7.3 in.)
Aiming Element (VLD)	655 nm +/- 10 nm
Illumination Element (LED)	625 nm +/- 5 nm
2D Imager Engine (SE4500-DPM) Specifications	
Field of View	Horizontal - 39.2° Vertical - 25.4°
Optical Resolution	WVGA 752 H x 480 V pixels (gray scale)
Roll	360°
Pitch Angle	+/- 60° from normal

Table A-1 MC67 Technical Specifications (Continued)

Item	Description
Skew Tolerance	+/- 60° from normal
Ambient Light	Indoor: 450 ft. candles (4845 lux) Outdoor: 9000 ft. candles (96,900 lux) Sunlight: 8000 ft. candles Fluorescent: 450 ft. candles
Focal Distance	From center of exit window: 18.5 cm (7.3 in.)
Aiming Element (VLD)	655 nm +/- 10 nm
Illumination Element (LED)	625 nm +/- 5 nm
Camera Specifications	
Resolution	8 Mega pixel

Table A-2 Data Capture Supported Symbologies

Item	Description		
1D Bar Codes	Chinese 2 of 5	Codabar	Code 11
	Code 128	Code 39	Code 93
	Coupon Code	Discrete 2 of 5	EAN-8
	EAN-13	GS1 DataBar	GS1 DataBar 14
	GS1 DataBar Expanded	GS1 DataBar Expanded Stacked	
	GS1 DataBar Limited	Interleaved 2 of 5	ISBT 128
	Korean 2 of 5	Matrix 2 of 5	MSI
	TLC39	Trioptic 39	UCC/EAN 128
	UPCA	UPCE	UPCE1
	UPC/EAN Supplementals	Webcode	
	2D Bar Codes	Australian Postal	Aztec
Composite AB		Composite C	Data Matrix
Dutch Postal		Japanese Postal	Linked Aztec
Maxi Code		Micro PDF-417	microQR
PDF-417		QR Code	US Planet
UK Postal		US Postnet	USPS 4-state (US4CB)

APPENDIX B KEYPADS

Introduction

The MC67 offers six types of keypad configurations: Numeric, QWERTY, QWERTZ, AZERTY, PIM and DSD.

Numeric Keypad Configuration

The numeric keypad contains application keys, scroll keys, and function keys. The keypad is color-coded to indicate the alternate function key (blue) values. Note that an application can change keypad functions so the MC67's keypad may not function exactly as described. See [Table B-1](#) for key and button descriptions and [Table B-2 on page B-4](#) for the keypad's special functions.

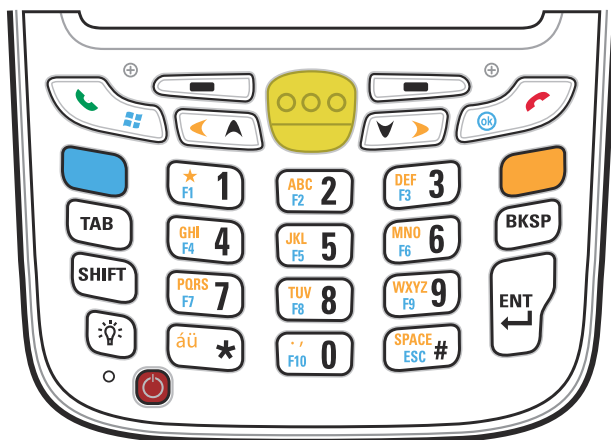

Figure B-1 MC67 Numeric Keypad

Table B-1 MC67 Numeric Keypad Descriptions











Key	Description
<p>Blue Key</p> 	<p>Use this key to launch applications or access items (shown on the keypad in blue). Press the Blue key once to activate this mode, followed by another key.</p> <p>A single press illuminates the key and displays the following icon at the bottom of the screen, until a second key is pressed: </p>
<p>Orange Key</p> 	<p>Use this key to access the secondary layer of characters and actions (shown on the keypad in orange). Press the Orange key once to lock the keypad into Alpha state. A single press illuminates the key and displays the following icon at the bottom of the screen: </p> <p>Press the Orange key a second time to return to the normal state.</p> <p>Press the Orange key, then the Shift key to add a temporary shift (that applies only to the next key pressed) to the orange lock state. This displays the following icon at the bottom of the screen: </p>
<p>Talk/Start Menu</p> 	<p>Talk (Green Phone): press to display the phone keypad window or to dial a phone number (from the phone keypad window).</p> <p>When on a phone call, press to place the call on hold.</p> <p>Use this key in conjunction with the Blue key to instantly display the <i>Start</i> menu from any application without tapping the screen. This function is user programmable.</p>
<p>Scan (yellow)</p> 	<p>Activates the imager in a scan enabled application or takes a picture or records a video in a camera application.</p>
<p>End/OK</p> 	<p>End (Red Phone): press when the phone keypad window displays to stop dialing or end a call.</p> <p>Use this key in conjunction with the Blue key as an OK or close button. This function is user programmable.</p>
<p>Scroll Up and Left</p> 	<p>Moves up one item.</p> <p>Moves left one item when pressed with the Orange key.</p>
<p>Scroll Down and Right</p> 	<p>Moves down one item.</p> <p>Moves right one item when pressed with the Orange key.</p>

Table B-1 MC67 Numeric Keypad Descriptions (Continued)



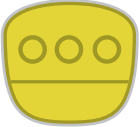





Key	Description
Soft Keys 	Accesses the command or menu above it on the screen.
Star 	Produces an asterisk in default state. Press and release the blue key, then press the Star key to open the <i>Start</i> menu.
Alphanumeric 	In default state, produces the numeric value on the key. In Alpha state, produces the lower case alphabetic characters on the key. Each key press produces the next alphabetic character in sequence. For example, press and release the Orange key and then press the '4' key once to produce the letter 'g'; press and release the Orange key and then press the '4' key three times to produce the letter 'i'. Press the SHIFT key in Alpha state to produce the upper case alphabetic characters on the key. For example, press and release the Orange key, press and release the SHIFT key, and then press the '4' key once to produce the letter 'G'; press and release the Orange key, press and release the SHIFT key and then press the '4' key three times to produce the letter 'I'.
Backspace 	Produces a backspace.
SHIFT 	Press and release the SHIFT key to activate the keypad alternate SHIFT functions. A single press displays the following icon at the bottom of the screen, until a second key is pressed:  Press the Orange key, then the Shift key to add a temporary shift (that applies only to the next key pressed) to the orange lock state. This displays the following icon at the bottom of the screen: 
Enter 	Executes a selected item or function.

Table B-2 Numeric Keypad Input Modes

Key	Numeric Mode			Orange Key (Alpha Lowercase Mode)				Orange + Shift Keys (Alpha Uppercase Mode)			
		Blue+ Key	SHIFT + Key	1st Press	2nd Press	3rd Press	4th Press	1st Press	2nd Press	3rd Press	4th Press
1	1	F1	!	*	*	*	*	*	*	*	*
2	2	F2	@	a	b	c		A	B	C	
3	3	F3	#	d	e	f		D	E	F	
4	4	F4	\$	g	h	i		G	H	I	
5	5	F5	%	j	k	l		J	K	L	
6	6	F6	^	m	n	o		M	N	O	
7	7	F7	&	p	q	r	s	P	Q	R	S
8	8	F8	*	t	u	v		T	U	V	
9	9	F9	(w	x	y	z	W	X	Y	Z
0	0	F10)	.				>			
Up	Up	Up	High- light Up	Left				Left			
Down	Down	Down	High- light Down	Right				Right			
Enter	Action	Action	Action	Action				Action			

Note: An application can change the key functions. The keypad may not function exactly as described.

Alpha-numeric Keypad Configurations

The three types of alpha-numeric keypads (QWERTY, AZERTY and QWERTZ) produce the 26-character alphabet (A-Z, both lowercase and uppercase), numbers (0-9), and assorted characters. The keypad is color-coded to indicate which modifier key to press to produce a particular character or action. The keypad default is alphabetic, producing lowercase letters. See [Table B-3](#) for key and button descriptions and [Table B-4 on page B-8](#) for the keypad's special functions. AZERTY keypad is used on configurations installed with the French operating system. QWERTZ keypad is used on configurations installed with the German operating system.



Figure B-2 QWERTY Keypad Configuration



Figure B-3 AZERTY Keypad Configuration



Figure B-4 QWERTZ Keypad Configuration

Table B-3 Alpha-numeric Keypad Descriptions







Key	Action
<p>Blue Key</p> 	<p>Press the Blue key once to activate this mode temporarily, followed by another key. This displays the following icon at the bottom of the screen, until a second key is pressed: </p> <p>Press the Blue key twice to lock this mode. This displays the following icon at the bottom of the screen: </p> <p>Press the Blue key a third time to unlock.</p>
<p>Orange Key</p> 	<p>Accesses the secondary layer of characters and actions (shown on the keypad in orange).</p> <p>Press the Orange key once to activate this mode temporarily, followed by another key. This displays the following icon at the bottom of the screen, until a second key is pressed: </p> <p>Press the Orange key twice to lock this mode. This displays the following icon at the bottom of the screen: </p> <p>Press the Orange key a third time to unlock.</p>
<p>Talk/Start Menu</p> 	<p>Talk (Green Phone): press to display the phone keypad window or to dial a phone number (from the phone keypad window).</p> <p>When on a phone call, press to place the call on hold.</p> <p>Use this key in conjunction with the Blue key to instantly display the <i>Start</i> menu from any application without tapping the screen. This function is user programmable.</p>
<p>Scan (yellow)</p> 	<p>Activates the imager in a scan enabled application or takes a picture or records a video in a camera application.</p>

Table B-3 Alpha-numeric Keypad Descriptions (Continued)







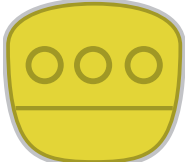



Key	Action
End/OK 	End (Red Phone): press when the phone keypad window displays to stop dialing or end a call. Use this key in conjunction with the Blue key as an OK or close button. This function is user programmable.
Scroll Up and Left 	Moves up one item. Moves left one item when pressed with the Orange key.
Scroll Down and Right 	Moves down one item. Moves right one item when pressed with the Orange key.
Soft Keys 	Accesses the command or menu above it on the screen.
Shift 	Changes the state of the alpha characters from lowercase to uppercase. <ul style="list-style-type: none"> • Press the Shift key to activate this mode temporarily, followed by another key. This displays the following icon at the bottom of the screen, until a second key is pressed:  • Press the Shift key twice to lock this mode. This displays the following icon at the bottom of the screen:  Press the Shift key a third time to unlock.
Backlight 	Turns the display backlight on and off.
Backspace 	Produces a backspace.
Enter 	Executes a selected item or function.

Table B-3 Alpha-numeric Keypad Descriptions (Continued)



Key	Action
Period 	Produces an period.
au 	Creates special characters.

Table B-4 QWERTY Keypad Input Modes

Key	Normal	Shift + Key	Orange + Key	Blue + Key
Q	q	Q	*	q
W	w	W	1	w
E	e	E	2	e
R	r	R	3	r
T	t	T	+	t
Y	y	Y	_	y
U	u	U	-	u
I	i	I	=	i
O	o	O	"	o
P	p	P	áü	p
A	a	A	#	a
S	s	S	4	s
D	d	D	5	d
F	f	F	6	f
G	g	G	(g
H	h	H)	h
J	j	J	/	j
K	k	K	:	k
L	l	L	'	l
Backspace	Backspace	Backspace	Backspace	Backspace
Shift	Shift	Shift-Lock	Shift	Shift

Note: An application can change the key functions. The keypad may not function exactly as described.

Table B-4 QWERTY Keypad Input Modes (Continued)

Key	Normal	Shift + Key	Orange + Key	Blue + Key
Z	z	Z	7	z
X	x	X	8	x
C	c	C	9	c
V	v	V	%	v
B	b	B	&	b
N	n	N	!	n
M	m	M	?	m
,	,	<	@	,
ENTER	Enter	Enter	Enter	Enter
0	0)	0	0
TAB	Tab	Tab	Back tab	Tab
SPACE	Space	Space	Space	Space
Backlight	Backlight	Backlight	Backlight	Backlight
. (Period)	.	>	.	.

Note: An application can change the key functions. The keypad may not function exactly as described.

Table B-5 AZERTY Keypad Input Modes

Key	Normal	Shift + Key	Orange + Key	Blue + Key
A	a	A	*	a
Z	z	Z	1	z
E	e	E	2	e
R	r	R	3	r
T	t	T	+	t
Y	y	Y	–	y
U	u	U	-	u
I	i	I	=	i
O	o	O	“	o
P	p	P	áü	p
Q	q	Q	#	q

Note: An application can change the key functions. The keypad may not function exactly as described.

Table B-5 AZERTY Keypad Input Modes (Continued)

Key	Normal	Shift + Key	Orange + Key	Blue + Key
S	s	S	4	s
D	d	D	5	d
F	f	F	6	f
G	g	G	(g
H	h	H)	h
J	j	J	/	j
K	k	K	:	k
L	l	L	'	l
Backspace	Backspace	Backspace	Backspace	Backspace
Shift	Shift	Shift-Lock	Shift	Shift
W	w	W	7	w
X	x	X	8	x
C	c	C	9	c
V	v	V	%	v
B	b	B	&	b
N	n	N	!	n
M	m	M	?	m
,	,	<	@	
Enter	Enter	Enter	Enter	Enter
0	0)	0	0
TAB	Tab	Tab	Back tab	Tab
SPACE	Space	Space	Space	Space
Backlight	Backlight	Backlight	Backlight	Backlight
.(Period)	.	>	.	.

Note: An application can change the key functions. The keypad may not function exactly as described.

Table B-6 QWERTZ Keypad Input Modes

Key	Normal	Shift + Key	Orange + Key	Blue + Key
Q	q	Q	*	q
W	w	W	1	w
E	e	E	2	e
R	r	R	3	r
T	t	T	+	t
Z	z	Z	-	z
U	u	U	-	u
I	i	I	=	i
O	o	O	"	o
P	p	P	áü	p
A	a	A	#	a
S	s	S	4	s
D	d	D	5	d
F	f	F	6	f
G	g	G	(g
H	h	H)	h
J	j	J	/	j
K	k	K	:	k
L	l	L	'	l
Backspace	Backspace			
Shift	Shift			
Y	y	Y	7	y
X	x	X	8	x
C	c	C	9	c
V	v	V	%	v
B	b	B	&	b
N	n	N	!	n
M	m	M	?	m
,	,	<	@	,

Note: An application can change the key functions. The keypad may not function exactly as described.

Table B-6 QWERTZ Keypad Input Modes (Continued)

Key	Normal	Shift + Key	Orange + Key	Blue + Key
ENTER	Enter	ENTER	ENTER	Enter
0	0)	0	0
TAB	Tab	Tab	Back tab	Tab
SPACE	Space	Space	Space	Space
Backlight	Backlight	Backlight	Backlight	Backlight
. (Period)	.	>	.	.

Note: An application can change the key functions. The keypad may not function exactly as described.

PIM Keypad Configuration

The PIM keypad contains application keys and scroll keys. Note that an application can change keypad functions so the MC67's keypad may not function exactly as described. See [Table B-7](#) for key and button descriptions.

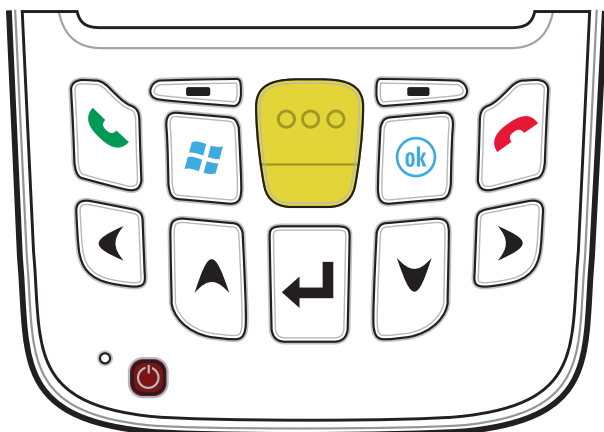

Figure B-5 PIM Keypad

Table B-7 PIM Keypad Descriptions









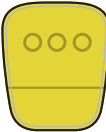

Key	Description
Talk (Green Phone) 	Talk (Green Phone): press to display the phone keypad window or to dial a phone number (from the phone keypad window). When on a phone call, press to place the call on hold. Use this key in conjunction with the Blue key to instantly display the <i>Start</i> menu from any application without tapping the screen. This function is user programmable.
End (Red Phone) 	End (Red Phone): press when the phone keypad window displays to stop dialing or end a call. Use this key in conjunction with the Blue key as an OK or close button. This function is user programmable.
Start 	Use this key to instantly display the Start menu from any application without tapping the screen. This function is user programmable.
Scan (yellow) 	Activates the imager in a scan enabled application or takes a picture or records a video in a camera application.
Scroll Up 	Moves up one item.

Table B-7 PIM Keypad Descriptions (Continued)

Key	Description
Scroll Down 	Moves up down item.
Scroll Left 	Moves left one item.
Scroll Right 	Moves right one item.
Soft Keys 	Accesses the command or menu above it on the screen.
Enter 	Executes a selected item or function.
OK 	Use this key as an OK or close button.

DSD Keypad Configuration

The Direct Store Delivery (DSD) keypad contains application keys, scroll keys, and function keys. The keypad is color-coded to indicate the alternate function key (blue) values. Note that an application can change keypad functions so the MC67's keypad may not function exactly as described. See [Table B-8](#) for key and button descriptions and [Table B-9 on page B-17](#) for the keypad's special functions.

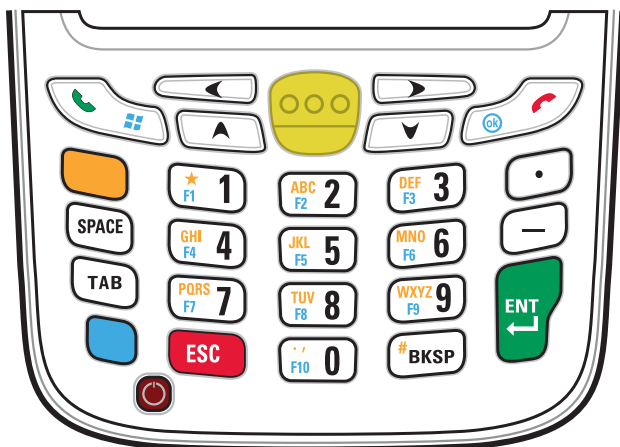

Figure B-6 MC67 DSD Keypad

Table B-8 MC67 DSD Keypad Descriptions







Key	Description
Blue Key 	Use this key to launch applications or access items (shown on the keypad in blue). Press the Blue key once to activate this mode, followed by another key. A single press illuminates the key and displays the following icon at the bottom of the screen, until a second key is pressed: 
Orange Key 	Use this key to access the secondary layer of characters and actions (shown on the keypad in orange). Press the Orange key once to lock the keypad into Alpha state. A single press illuminates the key and displays the following icon at the bottom of the screen:  Press the Orange key a second time to return to the normal state. Press the Orange key, then the Shift key to add a temporary shift (that applies only to the next key pressed) to the orange lock state. This displays the following icon at the bottom of the screen: 
Talk/Start Menu 	Talk (Green Phone): press to display the phone keypad window or to dial a phone number (from the phone keypad window). When on a phone call, press to place the call on hold. Use this key in conjunction with the Blue key to instantly display the <i>Start</i> menu from any application without tapping the screen. This function is user programmable.

Table B-8 MC67 DSD Keypad Descriptions (Continued)









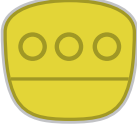

Key	Description
Scan (yellow) 	Activates the imager in a scan enabled application or takes a picture or records a video in a camera application.
End/OK 	End (Red Phone): press when the phone keypad window displays to stop dialing or end a call. Use this key in conjunction with the Blue key as an OK or close button. This function is user programmable.
Scroll Up 	Moves up one item. Moves left one item when pressed with the Orange key.
Scroll Down 	Moves down one item.
Scroll Left 	Moves left one item.
Scroll Right 	Moves right one item
SPACE 	Produces a space character.
Alphanumeric 	In default state, produces the numeric value on the key. In Alpha state, produces the lower case alphabetic characters on the key. Each key press produces the next alphabetic character in sequence. For example, press and release the Orange key and then press the '4' key once to produce the letter 'g'; press and release the Orange key and then press the '4' key three times to produce the letter 'i'.
Backspace 	Produces a backspace.
Period 	Produces a period character.

Table B-8 MC67 DSD Keypad Descriptions (Continued)





Key	Description
Tab 	Move from one field to the next.
ESC 	Exit the current operation.
Dash 	Produces a dash character.
Enter 	Executes a selected item or function.

Table B-9 DSD Keypad Input Modes

Key	Numeric Mode			Orange Key (Alpha Lowercase Mode)			
		Blue+ Key	SHIFT + Key	1st Press	2nd Press	3rd Press	4th Press
1	1	F1	!	*	*	*	*
2	2	F2	@	a	b	c	
3	3	F3	#	d	e	f	
4	4	F4	\$	g	h	i	
5	5	F5	%	j	k	l	
6	6	F6	^	m	n	o	
7	7	F7	&	p	q	r	s
8	8	F8	*	t	u	v	
9	9	F9	(w	x	y	z
0	0	F10)	.			

Note: An application can change the key functions. The keypad may not function exactly as described.

Table B-9 DSD Keypad Input Modes (Continued)

Key	Numeric Mode			Orange Key (Alpha Lowercase Mode)			
		Blue+ Key	SHIFT + Key	1st Press	2nd Press	3rd Press	4th Press
Up	Up	Up	Highlight Up	Left			
Down	Down	Down	Highlight Down	Right			
Enter	Action	Action	Action	Action			

Note: An application can change the key functions. The keypad may not function exactly as described.

Special Character Key

✓ **NOTE** Special characters are only available on the alpha-numeric keypad configurations.

To add special characters using the MC67 **áü** key, type the related character first, then press the Orange twice followed by the **áü (P)** key. Continue pressing the **áü** key until the special character displays. To modify an existing character, move the cursor to the right of the character then press the Orange key twice and then press the **áü** key until the special character replaces the original character. [Table B-10](#) lists the special characters the user can generate.

Table B-10 Special Characters

Key	Special Characters	Key	Special Characters
a	à á â ã ä å æ	A	À Á Â Ã Ä Å Æ
c	ç ć Ć ©	C	Ç Ć Ć ©
d	ð	D	Ð
e	è é ê ë ě	E	È É Ê Ë Ě
i	ì í î ï	I	Ì Í Î Ï
l		L	Ł ł
n	ñ	N	Ñ
o	ò ó ô õ ö ø œ	O	Ò Ó Ô Õ Ö Ø Æ
p	þ ƒ	P	þ ƒ
r	®	R	®
s	ş š ß	S	Ş Š ß
t	ţ	T	Ț
u	ù ú û ü	U	Ù Ú Û Ü

Table B-10 *Special Characters (Continued)*

Key	Special Characters		Key	Special Characters
y	ý		Y	Ÿ
z	ž ž		Z	Ž Ž
\$	€ £ ¥		/	\
“	' « »		([{ < «
)] } > »		+	± & - _
!	¡ ? ¿		.	¡ ; ;
*	#		@	~
%	^		,	¡ ; ;
#	*		&	- _ + ±
_	+ ± & -		'	« » "
?	¿ ! ¡		:	¡ ; ;
-	_ + ± &			

GLOSSARY

A

API. (Application Programming Interface) An interface by means of which one software component communicates with or controls another. Usually used to refer to services provided by one software component to another, usually via software interrupts or function calls

AZERTY. A standard keyboard commonly used on French keyboards. “AZERTY” refers to the arrangement of keys on the top row of keys.

AKU. (Adaptation Kit Update) Updates to the Windows Mobile operating system.

AFH. Adaptive Frequency Hopping

ActiveSync. ActiveSync is a data synchronization program developed by Microsoft for use with Windows Mobile operating systems.

B

Bar Code. A pattern of variable-width bars and spaces which represents numeric or alphanumeric data in machine-readable form. The general format of a bar code symbol consists of a leading margin, start character, data or message character, check character (if any), stop character, and trailing margin. Within this framework, each recognizable symbology uses its own unique format. See **Symbology**.

Bit. Binary digit. One bit is the basic unit of binary information. Generally, eight consecutive bits compose one byte of data. The pattern of 0 and 1 values within the byte determines its meaning.

Bits per Second (bps). Bits transmitted or received.

Bluetooth. A wireless protocol utilizing short-range communications technology facilitating data transmission over short distances.

boot or boot-up. The process a computer goes through when it starts. During boot-up, the computer can run self-diagnostic tests and configure hardware and software.

bps. See **Bits Per Second**.

Byte. On an addressable boundary, eight adjacent binary digits (0 and 1) combined in a pattern to represent a specific character or numeric value. Bits are numbered from the right, 0 through 7, with bit 0 the low-order bit. One byte in memory is used to store one ASCII character.

C

CDRH. Center for Devices and Radiological Health. A federal agency responsible for regulating laser product safety. This agency specifies various laser operation classes based on power output during operation.

CDRH Class 1. This is the lowest power CDRH laser classification. This class is considered intrinsically safe, even if all laser output were directed into the eye's pupil. There are no special operating procedures for this class.

CDRH Class 2. No additional software mechanisms are needed to conform to this limit. Laser operation in this class poses no danger for unintentional direct human exposure.

Character. A pattern of bars and spaces which either directly represents data or indicates a control function, such as a number, letter, punctuation mark, or communications control contained in a message.

Codabar. A discrete self-checking code with a character set consisting of digits 0 to 9 and six additional characters: (“-”, “\$”, “.”, “/”, “,” and “+”).

Code 128. A high density symbology which allows the controller to encode all 128 ASCII characters without adding extra symbol elements.

Code 3 of 9 (Code 39). A versatile and widely used alphanumeric bar code symbology with a set of 43 character types, including all uppercase letters, numerals from 0 to 9 and 7 special characters (“-”, “.”, “/”, “+”, “%”, “\$” and space). The code name is derived from the fact that 3 of 9 elements representing a character are wide, while the remaining 6 are narrow.

Code 93. An industrial symbology compatible with Code 39 but offering a full character ASCII set and a higher coding density than Code 39.

COM port. Communication port; ports are identified by number, e.g., COM1, COM2.

Cradle. A cradle is used for charging the terminal battery and for communicating with a host computer, and provides a storage place for the terminal when not in use.

D

DCP. See **Device Configuration Package**.

Decode. To recognize a bar code symbology (e.g., UPC/EAN) and then analyze the content of the specific bar code scanned.

Decode Algorithm. A decoding scheme that converts pulse widths into data representation of the letters or numbers encoded within a bar code symbol.

Decryption. Decryption is the decoding and unscrambling of received encrypted data. Also see, **Encryption** and **Key**.

Depth of Field. The range between minimum and maximum distances at which a scanner can read a symbol with a certain minimum element width.

Device Configuration Package. The Symbol Device Configuration Package provides the Product Reference Guide (PRG), flash partitions, Terminal Configuration Manager (TCM) and the associated TCM scripts. With this package hex images that represent flash partitions can be created and downloaded to the mobile computer.

Discrete 2 of 5. A binary bar code symbology representing each character by a group of five bars, two of which are wide. The location of wide bars in the group determines which character is encoded; spaces are insignificant. Only numeric characters (0 to 9) and START/STOP characters may be encoded.

E

EAN. European Article Number. This European/International version of the UPC provides its own coding format and symbology standards. Element dimensions are specified metrically. EAN is used primarily in retail.

EMDK. Enterprise Mobility Developer's Kit.

ESD. Electro-Static Discharge

F

File Transfer Protocol (FTP). A TCP/IP application protocol governing file transfer via network or telephone lines. See **TCP/IP**.

Flash Memory. Flash memory is nonvolatile, semi-permanent storage that can be electronically erased in the circuit and reprogrammed.

FHSS (Frequency Hopping Spread Spectrum). A method of transmitting radio signals by rapidly switching a carrier among many frequency channels, using a pseudorandom sequence known to both transmitter and receiver.

G

GPS (Global Positioning System). A satellite-based navigation system made up of a network of 24 satellites. GPS satellites circle the earth and transmit signal information to earth. GPS receivers take this information and use triangulation to calculate the user's exact location.

H

Hz. Hertz; A unit of frequency equal to one cycle per second.

Host Computer. A computer that serves other terminals in a network, providing such services as computation, database access, supervisory programs and network control.

I

IEC. International Electrotechnical Commission. This international agency regulates laser safety by specifying various laser operation classes based on power output during operation.

IEC (825) Class 1. This is the lowest power IEC laser classification. Conformity is ensured through a software restriction of 120 seconds of laser operation within any 1000 second window and an automatic laser shutdown if the scanner's oscillating mirror fails.

IEEE Address. See **MAC Address**.

Input/Output Ports. I/O ports are primarily dedicated to passing information into or out of the terminal's memory. MC67 mobile computers include USB ports.

Interleaved 2 of 5. A binary bar code symbology representing character pairs in groups of five bars and five interleaved spaces. Interleaving provides for greater information density. The location of wide elements (bar/spaces) within each group determines which characters are encoded. This continuous code type uses no intercharacter spaces. Only numeric (0 to 9) and START/STOP characters may be encoded.

Internet Protocol Address. See **IP**.

I/O Ports. The connection between two devices, defined by common physical characteristics, signal characteristics, and signal meanings. Types of interfaces include RS-232 and USB.

IP. Internet Protocol. The IP part of the TCP/IP communications protocol. IP implements the network layer (layer 3) of the protocol, which contains a network address and is used to route a message to a different network or subnetwork. IP accepts "packets" from the layer 4 transport protocol (TCP or UDP), adds its own header to it and delivers a "datagram" to the layer 2 data link protocol. It may also break the packet into fragments to support the maximum transmission unit (MTU) of the network.

IP Address. (Internet Protocol address) The address of a computer attached to an IP network. Every client and server station must have a unique IP address. A 32-bit address used by a computer on a IP network. Client workstations have either a permanent address or one that is dynamically assigned to them each session. IP addresses are written as four sets of numbers separated by periods; for example, 204.171.64.2.

IPX/SPX. Internet Package Exchange/Sequential Packet Exchange. A communications protocol for Novell. IPX is Novell's Layer 3 protocol, similar to XNS and IP, and used in NetWare networks. SPX is Novell's version of the Xerox SPP protocol.

ISM. Industry Scientific and Medical

K

Key. A key is the specific code used by the algorithm to encrypt or decrypt the data. Also see, **Encryption** and **Decrypting**.

L

LASER. Light Amplification by Stimulated Emission of Radiation. The laser is an intense light source. Light from a laser is all the same frequency, unlike the output of an incandescent bulb. Laser light is typically coherent and has a high energy density.

laser scanner. A type of bar code reader that uses a beam of laser light.

LCD. See **Liquid Crystal Display**.

LED Indicator. A semiconductor diode (LED - Light Emitting Diode) used as an indicator, often in digital displays. The semiconductor uses applied voltage to produce light of a certain frequency determined by the semiconductor's particular chemical composition.

Light Emitting Diode. See **LED**.

Liquid Crystal Display (LCD). A display that uses liquid crystal sealed between two glass plates. The crystals are excited by precise electrical charges, causing them to reflect light outside according to their bias. They use little electricity and react relatively quickly. They require external light to reflect their information to the user.

M

MC. Mobile Computer.

MDN. Mobile Directory Number. The directory listing telephone number that is dialed (generally using POTS) to reach a mobile unit. The MDN is usually associated with a MIN in a cellular telephone -- in the US and Canada, the MDN and MIN are the same value for voice cellular users. International roaming considerations often result in the MDN being different from the MIN.

MIN. Mobile Identification Number. The unique account number associated with a cellular device. It is broadcast by the cellular device when accessing the cellular system.

Mobile Computer. In this text, *mobile computer* refers to the MC67. It can be set up to run as a stand-alone device, or it can be set up to communicate with a network, using wireless radio technology.

N

Nominal. The exact (or ideal) intended value for a specified parameter. Tolerances are specified as positive and negative deviations from this value.

NVM. Non-Volatile Memory.

O

Open System Authentication. Open System authentication is a null authentication algorithm.

P

PAN . Personal Area Network. Using Bluetooth wireless technology, PANs enable devices to communicate wirelessly. Generally, a wireless PAN consists of a dynamic group of less than 255 devices that communicate within about a 33-foot range. Only devices within this limited area typically participate in the network.

PING. (Packet Internet Groper) An Internet utility used to determine whether a particular IP address is online. It is used to test and debug a network by sending out a packet and waiting for a response.

Q

QWERTY. A standard keyboard commonly used on European keyboards. "QWERTY" refers to the arrangement of keys on the top row of keys.

QWERTZ. A standard keyboard commonly used on German keyboards. "QWERTZ" refers to the arrangement of keys on the top row of keys.

R

RAM. Random Access Memory. Data in RAM can be accessed in random order, and quickly written and read.

RF. Radio Frequency.

ROM. Read-Only Memory. Data stored in ROM cannot be changed or removed.

Router. A device that connects networks and supports the required protocols for packet filtering. Routers are typically used to extend the range of cabling and to organize the topology of a network into subnets. See **Subnet**.

S

Scanner. An electronic device used to scan bar code symbols and produce a digitized pattern that corresponds to the bars and spaces of the symbol. Its three main components are: 1) Light source (laser or photoelectric cell) - illuminates a bar code.; 2) Photodetector - registers the difference in reflected light (more light reflected from spaces); 3) Signal conditioning circuit - transforms optical detector output into a digitized bar pattern.

SDK. Software Development Kit

Shared Key. Shared Key authentication is an algorithm where both the AP and the MU share an authentication key.

SID. System Identification code. An identifier issued by the FCC for each market. It is also broadcast by the cellular carriers to allow cellular devices to distinguish between the home and roaming service.

Space. The lighter element of a bar code formed by the background between bars.

Specular Reflection. The mirror-like direct reflection of light from a surface, which can cause difficulty decoding a bar code.

Start/Stop Character. A pattern of bars and spaces that provides the scanner with start and stop reading instructions and scanning direction. The start and stop characters are normally to the left and right margins of a horizontal code.

Subnet. A subset of nodes on a network that are serviced by the same router. See **Router**.

Subnet Mask. A 32-bit number used to separate the network and host sections of an IP address. A custom subnet mask subdivides an IP network into smaller subsections. The mask is a binary pattern that is matched up with the IP address to turn part of the host ID address field into a field for subnets. Default is often 255.255.255.0.

Substrate. A foundation material on which a substance or image is placed.

Symbol. A scannable unit that encodes data within the conventions of a certain symbology, usually including start/stop characters, quiet zones, data characters and check characters.

Symbol Aspect Ratio. The ratio of symbol height to symbol width.

Symbol Height. The distance between the outside edges of the quiet zones of the first row and the last row.

Symbol Length. Length of symbol measured from the beginning of the quiet zone (margin) adjacent to the start character to the end of the quiet zone (margin) adjacent to a stop character.

Symbology. The structural rules and conventions for representing data within a particular bar code type (e.g. UPC/EAN, Code 39, PDF417, etc.).

T

TCP/IP. (Transmission Control Protocol/Internet Protocol) A communications protocol used to internetwork dissimilar systems. This standard is the protocol of the Internet and has become the global standard for communications. TCP provides transport functions, which ensures that the total amount of bytes sent is received correctly at the other end. UDP is an alternate transport that does not guarantee delivery. It is widely used for real-time voice and video transmissions where erroneous packets are not retransmitted. IP provides the routing mechanism. TCP/IP is a routable protocol, which means that all messages contain not only the address of the destination station, but the address of a destination network. This allows TCP/IP messages to be sent to multiple networks within an organization or around the world, hence its use in the worldwide Internet. Every client and server in a TCP/IP network requires an IP address, which is either permanently assigned or dynamically assigned at startup.

Telnet. A terminal emulation protocol commonly used on the Internet and TCP/IP-based networks. It allows a user at a terminal or computer to log onto a remote device and run a program.

Terminal. See **Mobile Computer**.

Terminal Emulation. A "terminal emulation" emulates a character-based mainframe session on a remote non-mainframe terminal, including all display features, commands and function keys. The VC5000 Series supports Terminal Emulations in 3270, 5250 and VT220.

TFTP. (Trivial File Transfer Protocol) A version of the TCP/IP FTP (File Transfer Protocol) protocol that has no directory or password capability. It is the protocol used for upgrading firmware, downloading software and remote booting of diskless devices.

Tolerance. Allowable deviation from the nominal bar or space width.

Transmission Control Protocol/Internet Protocol. See **TCP/IP**.

Trivial File Transfer Protocol. See **TFTP**.

U

UDP. User Datagram Protocol. A protocol within the IP protocol suite that is used in place of TCP when a reliable delivery is not required. For example, UDP is used for real-time audio and video traffic where lost packets are simply ignored, because there is no time to retransmit. If UDP is used and a reliable delivery is required, packet sequence checking and error notification must be written into the applications.

UPC. Universal Product Code. A relatively complex numeric symbology. Each character consists of two bars and two spaces, each of which is any of four widths. The standard symbology for retail food packages in the United States.

V

Visible Laser Diode (VLD). A solid state device which produces visible laser light.

INDEX

Numerics

2-D bar codes 3-1

A

accessories 10-1
 auto charge cable 10-2
 cables 10-13
 charge only cable 10-2
 communication/charge cables
 battery charging 10-13
 LED indicators 10-14
 fabric holster 10-2
 four slot charge only cradle 10-1, 10-7
 four slot Ethernet cradle 10-1, 10-8
 four slot spare battery charger 10-1, 10-12
 holster 10-2
 MMC 1-2, 10-3
 screen protector 10-2
 SD card 10-3
 SIM card 1-3
 single slot USB cradle 10-3
 spare battery 10-2
 spring loaded stylus 10-2
 stylus 10-2
 USB charging cable 10-2
 USB cradle 10-1
 vehicle cradle 10-1, 10-10
 vehicle holder 10-1
 wall mounting kit, cradle 10-2
ActiveSync 2-11
adaptive frequency hopping 7-1
adjusting volume 2-12
AFH 7-1
Alpha-numeric keypad B-5
alpha-numeric keypad

 key descriptions B-6
answering a call 4-4
auto charge cable 10-2, 10-13
AZERTY B-5

B

bar codes
 two dimensional 3-1
battery
 charging 1-5, 10-3, 10-7, 10-8, 10-10, 10-12
 check status 1-6
 installing 1-4
 removing 1-7
battery chargers
 communication/charge cables 10-13
 LED indicators 10-14
 four slot 10-12
battery charging 1-5
 communication/charge cables 10-13
 using four slot charge only cradle 10-7
 using four slot Ethernet cradle 10-8
 using four slot spare battery charger 10-12
 using single slot USB cradle 10-3
 using vehicle cradle 10-10
battery icon 2-8, 2-14
Bluetooth 7-1
 adaptive frequency hopping 7-1
 bonding 7-30
 deleting bonded device 7-31
 security 7-2
 turning off 7-6, 7-14
 turning on 7-6, 7-14
bluetooth
 communicating icon 2-7
 disabled icon 2-7
 discovering devices 7-7, 7-15

- enabled icon 2-7
- turning on and off 7-6, 7-14
- bonding
 - Bluetooth 7-30
- boot
 - cold 2-12, 7-5
 - warm 2-12, 7-5
- bullets xv
- buttons
 - power 2-12, 2-18

C

- cables 10-13
 - auto charge cable 10-2
 - connecting 10-13
- calculator 2-10
- calendar 2-10
- calibrating the screen 1-6
- call history 4-6, 4-7
- charge only cable 10-2, 10-13
- charge only cradle 10-1
- charging
 - spare batteries 1-6, 10-4, 10-12
 - using four slot charge only cradle 10-7
 - using four slot Ethernet cradle 10-8
 - using four slot spare battery charger 10-12
 - using single slot USB cradle 10-3
 - using vehicle cradle 10-10
- charging indicators 2-2, 10-14
 - four slot charge only cradle 10-7
 - four slot spare battery charger 10-12
 - single slot USB cradle 10-4
 - vehicle cradle 10-11
- charging temperature 1-6, 10-4
- cleaning 11-1
- clock & alarms 9-1
- cold boot 2-12, 7-5
- command bar
 - icons 2-7, 2-9
- communication 10-13
- communication/charge cables 10-13
 - battery charging 10-13
 - LED indicators 10-14
- conference call 4-10
- configuration xiii
- Contacts 2-10
- contacts 2-10
- contacts application 4-3
- conventions
 - notational xv
- cradles
 - four slot charge only 10-1, 10-7
 - four slot charge only cradle 10-7

- four slot Ethernet 10-1, 10-8
- four slot spare battery charger 10-12
- single slot USB 10-3
- vehicle 10-10

D

- data capture xiii
- digital camera 3-1
- dot aiming 3-3
- imager operational modes
 - decode mode 3-1
 - image capture mode 3-2
 - pick list mode 3-2
- imaging 3-1
 - scan angle 3-2
 - scan range 3-2
 - scanning 3-3, 3-4
 - two dimensional bar codes 3-1
- deleting Bluetooth bond 7-31
- display xiii
- dual line SIM 6-5

E

- emergency calls 4-5
- ESD 1-2
- Ethernet cradle 10-8

F

- fabric holster 10-2
- file explorer 2-11
- four slot charge only cradle
 - charging 10-7
 - charging indicators 10-7
- four slot Ethernet cradle 10-1, 10-8
 - charging 10-8
- four slot spare battery charger 10-1, 10-12
 - charging 10-12
 - charging indicators 10-12
 - setup 10-12

H

- hard reset 2-12, 7-5
- headset 4-6
- hexadecimal keys 5-4
- High-Speed Downlink Packet Access 4-1
- holster 10-2

I

- icons

- battery 2-8, 2-14
 - bluetooth communicating 2-7
 - bluetooth disabled 2-7
 - bluetooth enabled 2-7
 - speaker 2-12
 - status 2-7
 - task tray 2-7, 2-9
 - wireless applications 2-7
 - wireless status 2-7
 - imager. See data capture, imaging
 - imager. See data capture, imaging, imagersample
 - imaging 3-1, 3-2
 - information, service xvi
 - installing battery 1-4
 - Internet Explorer Mobile 2-10
 - internet sharing 2-11
 - IrDA 9-1
- K**
- key descriptions
 - alpha-numeric keypad B-6
 - numeric keypad B-2, B-13, B-15
 - keypads xiii
 - input modes B-4, B-8, B-9, B-11, B-17
 - key descriptions B-2, B-6, B-13, B-15
 - numeric B-1, B-13, B-15
 - QWERTY B-5
 - special character key B-18
 - types B-1
- L**
- LEDs 2-2
 - battery status 2-3
 - charging 2-3, 10-4, 10-7, 10-11, 10-12, 10-14
 - radio status 2-3
 - scan and decode 2-2, 3-3, 3-4
 - lithium-ion battery 1-1
 - locking the MC67 keypad 9-4
- M**
- main battery
 - charging 1-2, 1-5
 - installing 1-2
 - maintenance 11-1
 - masked characters 5-4
 - Media Player 2-10
 - memory xiii
 - messaging 2-10
 - MMC 1-2, 10-3
 - MSP Agent 2-11
 - multi media card 1-2, 10-3
- muting a call 4-6
- N**
- navigation bar
 - icons 2-7
 - notational conventions xv
 - notes 2-10
 - notes application 4-6
 - numeric keypad B-1, B-13, B-15
 - input modes B-4, B-17
 - key descriptions B-2, B-13, B-15
- O**
- operating system xiii
- P**
- pass-phrase 5-4
 - passwords 9-4
 - phone
 - answering a call 4-4
 - call history 4-7
 - call swapping 4-10
 - conference call 4-10
 - contacts 4-3
 - muting a call 4-6
 - speed dial
 - adding entry 4-11
 - calling 4-4
 - deleting entry 4-14
 - editing entry 4-13
 - taking notes 4-6
 - text messaging 6-2
 - three-way call 4-10
 - using keypad 4-1
 - pictures 2-10
 - editing 3-7
 - power button 2-12, 2-18
- Q**
- QWERTY keypad
 - input modes B-8, B-9, B-11
 - QWERTZ keypad B-5
- R**
- radios xiii
 - rapid deployment 2-11
 - removing main battery 1-7
 - reset 2-12
 - hard 2-12, 7-5

soft 2-12, 7-5
 resume 7-6
 rigid holster 10-2

S

scanning
 imaging 3-1
 screen
 calibration 1-6
 screen protector 10-2
 SD 10-3
 secure digital card 10-3
 security
 Bluetooth 7-2
 service information xvi
 settings 9-1
 about 9-2
 beam 9-1
 buttons 9-2
 certificates 9-2
 connections 9-1
 customer feedback 9-2
 encryption 9-2
 error reporting 9-2
 external GPS 9-2
 lock 9-1
 memory 9-3
 owner information 9-2
 power 9-3
 regional settings 9-3
 remove programs 9-3
 screen 9-3
 sounds & notifications 9-1
 Wi-Fi 9-2
 wireless manager 9-2
 SIM card
 accessories 1-3
 install 1-3
 single slot USB cradle 10-3
 charging 10-3
 charging indicators 10-4
 Single-slot Ethernet/modem/USB cradle 10-5
 soft reset 2-12, 7-5
 spare battery
 3600 mAh 10-2
 charging 1-6, 10-4, 10-12
 spare battery charger
 charging 10-12
 charging indicators 10-12
 setup 10-12
 speaker icon 2-12
 special character key B-18
 speed dial 4-4, 4-11

spring loaded stylus 10-2
 starting the EDA 1-2, 1-6
 status icon 2-7
 battery 2-8, 2-14
 speaker 2-12
 strap 1-1
 stylus 1-1, 2-18, 10-2
 subscriber identification module 1-3
 suspend 1-7, 1-8, 7-5
 synchronize with PC
 using Bluetooth 7-12

T

task tray icons 2-6
 tasks 2-10
 temperature A-2
 charging 1-6, 10-4
 three-way call 4-10
 troubleshooting 11-5

U

unpacking 1-1
 USB charge cable 10-13
 USB charging cable 10-2
 USB client charge cable 10-13
 USB cradle 10-1
 using stylus 2-18
 using wired headset 4-6

V

vehicle cradle 10-1, 10-10
 charging indicators 10-11
 vehicle holder 10-1
 videos 2-10

W

wall mounting kit, cradle 10-2
 warm boot 2-12, 7-5
 Windows Live 2-10
 Windows Live Messenger 2-10
 wired headset 4-6
 wireless manager 9-2
 wireless status 2-7
 WLAN 802.11a/b/g xiii
 WPAN Bluetooth xiii



Zebra Technologies Corporation
Lincolnshire, IL U.S.A.
<http://www.zebra.com>

Zebra and the Zebra head graphic are registered trademarks of ZIH Corp. The Symbol logo is a registered trademark of Symbol Technologies, Inc., a Zebra Technologies company.
© 2015 Symbol Technologies, Inc.

